

Agilent 81101A 50 MHz Pulse Generator

Quick Start Guide



Agilent Technologies

Front Panel Display and Softkeys

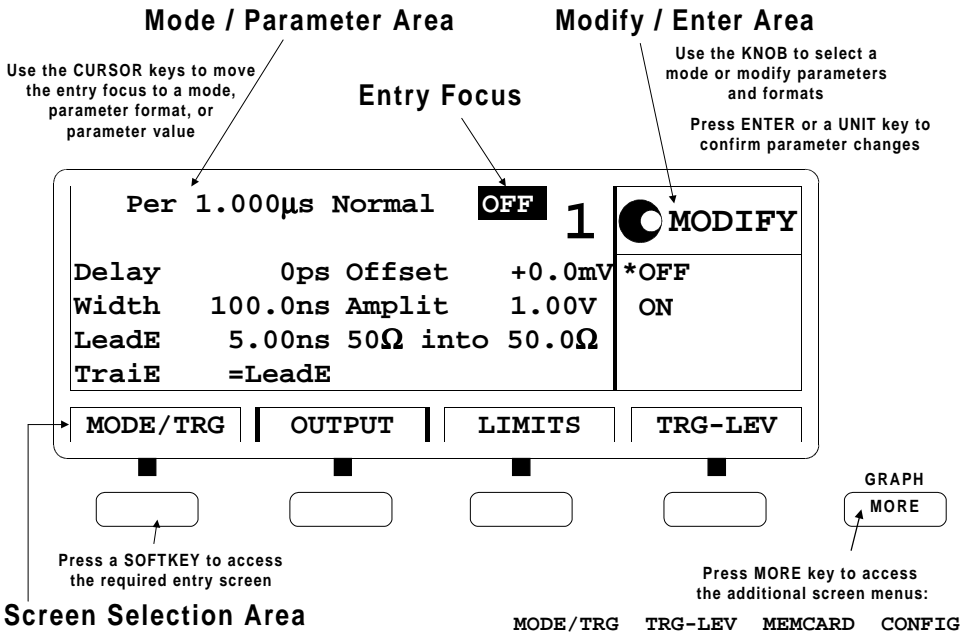

Quick Start Guide

Agilent 81101A 50 MHz
Pulse Generator

Part No. 81101-91020
Printed in Germany March 2000
Edition 1.1, E0300

Notice

Copyright

© 1998 Agilent Technologies 1998, 2000. All rights reserved.

No part of this manual may be reproduced in any form or by any means (including electronic storage and retrieval or translation into a foreign language) without prior agreement and written consent from Agilent Technologies Inc. as governed by United States and international copyright laws.

Notice

The material contained in this document is subject to change without notice. Agilent Technologies makes no warranty of any kind with regard to this material, including, but not limited to, the implied warranties of merchantability and fitness for a particular purpose. Agilent Technologies shall not be liable for errors contained herein or for incidental or consequential damages in connection with the furnishing, performance, or use of this material.

Warranty

This Agilent Technologies product has a warranty against defects in material and workmanship for a period of three years from date of shipment. During the warranty period, Agilent Technologies will, at its option, either repair or replace products that prove to be defective. For warranty service or repair, this product must be returned to a service facility designated by Agilent Technologies. The Buyer shall pay Agilent Technologies round-trip travel expenses. For products returned to Agilent Technologies for warranty service, the Buyer shall prepay shipping charges to Agilent Technologies and Agilent Technologies shall pay shipping charges to return the product to the Buyer. However, the Buyer shall pay all shipping charges, duties and taxes for products returned to Agilent Technologies from another country.

Agilent Technologies warrants that its software and firmware designated by Agilent Technologies for use with an instrument will execute its programming instructions when properly installed on that instrument. Agilent Technologies does not warrant that the operation of the instrument software, or firmware, will be uninterrupted or error free.

Limitation of Warranty

The foregoing warranty shall not apply to defects resulting from improper or inadequate maintenance by the Buyer, Buyer-supplied software or interfacing, unauthorized modification or misuse, operation outside of the environmental specifications for the product, or improper site preparation or maintenance. No other warranty is expressed or implied. Agilent Technologies specifically disclaims the implied warranties of merchantability and fitness for a particular purpose.

Exclusive Remedies

The remedies supplied are the Buyer's sole and exclusive remedies. Agilent Technologies shall not be liable for any direct, indirect, special, incidental, or consequential damages, whether based on contract, tort or any other legal theory.

Certification

Agilent Technologies certifies that this product met its published specifications at the time of shipment. Agilent Technologies further certifies that its calibration measurements are traceable to the United States Institute of Standards and Technology, to the extent allowed by the Institute's calibrating facility, and to the calibration facilities of other International Standards Organization members.

Services and Support

Any adjustment, maintenance, or repair of this product must be performed by qualified personnel. Contact your customer engineer through your local Agilent Technologies Service Center. You can find a list of local service representatives on the Web at:

<http://www.agilent.com/Service/English/index.html>

Safety Summary

The following general safety precautions must be observed during all phases of operation of this instrument. Failure to comply with these precautions or with specific warnings elsewhere in this manual violates safety standards of design, manufacture, and intended use of the instrument. Agilent Technologies Inc. assumes no liability for the customer's failure to comply with these requirements.

General

This product is a Safety Class 1 instrument (provided with a protective earth terminal). The protective features of this product may be impaired if it is used in a manner not specified in the operation instructions.

All Light Emitting Diodes (LEDs) used in this product are Class 1 LEDs as per IEC 60825-1.

Environmental Conditions

This instrument is intended for indoor use in an installation category II, pollution degree 2 environment. It is designed to operate at a maximum relative humidity of 95% and at altitudes of up to 2000 meters. Refer to the specifications tables for the ac mains voltage requirements and ambient operating temperature range.

Before Applying Power

Verify that the product is set to match the available line voltage, the correct fuse is installed, and all safety precautions are taken. Note the instrument's external markings described under *“Safety Symbols” on page 8*.

Ground the Instrument

To minimize shock hazard, the instrument chassis and cover must be connected to an electrical protective earth ground. The instrument must be connected to the ac power mains through a grounded power cable, with the ground wire firmly connected to an electrical ground (safety ground) at the power outlet. Any interruption of the protective (grounding) conductor or disconnection of the protective earth terminal will cause a potential shock hazard that could result in personal injury.

Fuses

Only fuses with the required rated current, voltage, and specified type (normal blow, time delay, etc.) should be used. Do not use repaired fuses or short-circuited fuse holders. To do so could cause a shock or fire hazard.

Do Not Operate in an Explosive Atmosphere

Do not operate the instrument in the presence of flammable gases or fumes.

Do Not Remove the Instrument Cover

Operating personnel must not remove instrument covers. Component replacement and internal adjustments must be made only by qualified service personnel.

Instruments that appear damaged or defective should be made inoperative and secured against unintended operation until they can be repaired by qualified service personnel.

Safety Summary

Safety Symbols



Caution (refer to accompanying documents)



Protective earth (ground) terminal

In the manuals:

WARNING

The WARNING sign denotes a hazard. It calls attention to a procedure, practice, or the like, which, if not correctly performed or adhered to, could result in personal injury. Do not proceed beyond a WARNING sign until the indicated conditions are fully understood and met.

CAUTION

The CAUTION sign denotes a hazard. It calls attention to an operating procedure, or the like, which, if not correctly performed or adhered to, could result in damage to or destruction of part or all of the product. Do not proceed beyond a CAUTION sign until the indicated conditions are fully understood and met.

About this Book

This quick start guide helps you to quickly get familiar with the features and the user interface of the Agilent 81101A Pulse Generator.

Chapter 1 “Introducing the Agilent 81101A Pulse Generator” on page 15 gives a general overview of the Agilent 81101A, its features, the user interface, and the steps required for operating the instrument.

For getting started *Chapter 2 “Getting Started” on page 29* gives the setup information for some real-world signal examples, which can easily be used by varying only some parameter values.

Chapter 3 “Using the Agilent 81101A” on page 43 provides complete information on the user interface screens.

Installation and maintenance are described in *Appendix A “Installation & Maintenance” on page 75*.

For specifications and information on operating the instrument by means of remote control, please refer to the *Reference Guide*, p/n 81101-91021.

Conventions Used in this Book

This book uses certain conventions to indicate elements of the Agilent 81101A's user interface. The following table shows some examples:

Softkeys	Press the MODE/TRG softkey to access the Mode/Trigger screen.
Hardkeys	Press the MORE key to switch to the alternative softkey layout.
Alternate Keys	Press SHIFT + 0 (ON/OFF) to switch on the output. The alternate key label—which is selected by pressing the SHIFT key—is given in parentheses.
Screen Quotes	Move the entry focus down to PULSE-PERIOD and turn the knob to select INTERNAL PLL.
Entry Focus	The highlight field, that can be moved with the cursor keys, to change modes, parameters, or parameter formats.

Contents

	Notice	4
	Safety Summary	6
	About this Book	9
Chapter 1	Introducing the Agilent 81101A Pulse Generator	
	What you can do with the Agilent 81101A	16
	The Front Panel	18
	Operating the Agilent 81101A	20
	Switching On the Instrument	20
	The Basic Screens	21
	Adjusting Parameters	23
	Switching the Output On and Off	26
	Using the Special Function Keys	26
	Help is Available	27
	The Rear Panel	28
Chapter 2	Getting Started	
	Setting Up a Clock Signal	30
	Setting Up a Pulse Signal	35
	Setting Up a Burst Signal	39

Contents

Chapter 3 Using the Agilent 81101A

The Mode/Trigger Screen	44
Overview	44
Continuous Pulses Mode	46
Continuous Burst Mode	47
Triggered Pulses Mode	48
Triggered Burst Mode	50
Gated Pulses Mode	52
Gated Burst Mode	54
External Width Mode	55
The Output Screen	56
Timing Parameters	56
Level Parameters	61
The Limits Screen	64
The Trigger-Level Screen	65
Threshold and Impedance Parameters	65
Trigger and Strobe Level Parameters	66
The Memory Card Screen	67
The Configuration Screen	70
Warnings and Errors	72

Appendix A Installation & Maintenance

Initial Inspection	76
Standard Deliverables	77
Options and Accessories:	78

Contents

Power Requirements	80
Power Cable	82
Ventilation Requirements	83
Thermal Protection	83
Battery	84
Battery Replacement	85
Operating Environment	86
Cleaning Recommendation	87
Acoustic Noise Emission	88

Contents

1

Introducing the Agilent 81101A Pulse Generator

The purpose of the introduction chapter is to give a general overview of the Agilent 81101A.

The main features and use models are described in *“What you can do with the Agilent 81101A” on page 16.*

Operating the instrument via the front panel user interface is described in *“The Front Panel” on page 18* and *“Operating the Agilent 81101A” on page 20.*

“Help is Available” on page 27 shortly introduces the Agilent 81101A’s on-line help system.

Finally, *“The Rear Panel” on page 28* takes a look at the back of the Agilent 81101A.

What you can do with the Agilent 81101A

This section introduces the basic features and use models of the Agilent 81101A Pulse Generator.

Basic Features

The Agilent 81101A is a single-channel pulse generator with variable transition times. It is capable of generating all standard pulses and bursts of pulses needed to test current logic technologies (for example, TTL, CMOS, ECL, PECL, LVDS, GTL) and other digital designs up to 50 MHz.

The instrument features two internal oscillators:

- a synchronously triggerable internal oscillator
- an accurate, stable internal PLL

For even more accuracy, an external frequency reference can be connected.

Any timing parameter can be varied without glitch or drop out. This contributes to more accurate and confident characterizations of the device under test (DUT).

Complete signal setups can be stored locally (9 internal non-volatile registers available) or on a memory card.

Benchtop Testing

The Agilent 81101A features a graphic display showing all pulse parameters at a glance. The cursor keys and the modify knob allow fast and simple operation.

The user interface is designed to minimize the time invested in getting familiar with the instrument. After familiarization, the instrument supports quick setups of signals. This leaves you free to concentrate on the measurement task and testing of the DUT.

Automated Testing

The Agilent 81101A features an GP-IB/SCPI-conform command structure for all features. Using this programming interface, the instrument can be easily integrated into all phases of test system development such as planning rack integration and test program generation.

Programs designed for the Agilent 81101A are compatible with all other models of the Agilent 81100 family.

NOTE

For a command reference list, please refer to the *Reference Guide*, part number 81101-91021.

The Front Panel

When used for benchtop testing, the instrument is mainly operated from the front panel.

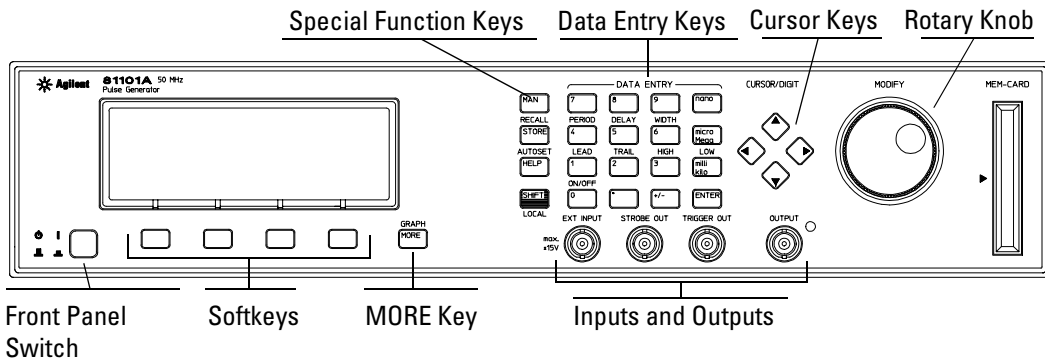

The **front panel switch** is used to switch on and off the instrument.

NOTE

When the front panel switch is off, the instrument is in “standby” mode. The instrument is disconnected from the AC line power *only* by disconnecting the power cord.

The four keys below the display are the **softkeys** (software-controlled keys). The current function of each softkey is indicated in the corresponding box on the display.

Pressing the MORE key changes the softkey layout.

The other keys (**special function keys, data entry keys, cursor keys**) and the **rotary knob** are used to select and modify parameters when operating the instrument (see [“Operating the Agilent 81101A” on page 20](#)).

The major inputs and outputs of the instrument are available at the front panel:

- The external input (EXT INPUT) can be used to connect an external arming source (triggered or gated modes), or to perform pulse recovery (external width mode). For details, please refer to *“The Mode/Trigger Screen” on page 44*.
- The strobe output (STROBE OUT) provides a signal indicating the duration of a burst.

In burst mode, the STROBE OUT signal marks the start and end of each burst of pulses generated. The rising edge of the STROBE signal is synchronized to the start of the first pulse period in a burst, the falling edge is synchronized to the start of the last pulse period in the burst. (see *“The Mode/Trigger Screen” on page 44*).

You can set the output levels to TTL or ECL (see *“The Trigger-Level Screen” on page 65*)

- The trigger signal (TRIGGER OUT) marks the start of each pulse period (see *“The Mode/Trigger Screen” on page 44*). You can set the output levels to TTL or ECL (see *“The Trigger-Level Screen” on page 65*).
- The OUTPUT provides the signal output, the indicator shows the current state of the output (on or off).

NOTE

An input connector for external frequency reference (CLOCK/REF INP.) is available at the rear panel (see *“The Rear Panel” on page 28*). When the rear panel option UN2 is ordered, all input and output connectors are available at the rear panel.

NOTE

For information on the use of the memory card slot, refer to *“The Memory Card Screen” on page 67*.

Operating the Agilent 81101A

This section guides you through the first steps when operating the Agilent 81101A via the user interface.

NOTE

For information on operating the Agilent 81101A via remote control, please refer to the *Reference Guide*, part number 81101-91021.

Switching On the Instrument



After switching on the instrument the display indicates that the instrument selftest is running. This can take several seconds to complete.

If the selftest fails, you see a flashing E at the bottom of the screen. Press the HELP key to see a list of the selftest error messages. Use the knob or the cursor keys to scroll through the list if necessary.

To return to normal operation press HELP again. Note that the selftest error messages are removed from the error queue after this.

The Basic Screens

The major parameters for pulse generation can be set up in only two screens.

The **Mode/Trigger** screen allows you to set the fundamental operating and trigger modes with respect to the signal required.

CONTINUOUS	PULSES	<input checked="" type="radio"/> MODIFY	
	Single-Pulses at Out1		*PulseStrm
	Pulse-Period: internal Osc	Burst	
MODE/TRG	OUTPUT	LIMITS	TRG-LEV

*Press the MODE/
TRG softkey to
access this screen.*

In this screen, you can set up the signal to be triggered or continuous, and to be a pulse stream or a burst (several pulses followed by a pause) consisting of single or double pulses.

In the lower section you can specify the frequency source for the pulse period and the trigger source.

Introducing the Agilent 81101A Pulse Generator
Operating the Agilent 81101A

The **Output** screen allows you to specify timing and level parameters for the signal to be generated.

Per 1.000µs Normal				OFF	1	<input type="radio"/> MODIFY
Delay	0ps	Offset	+0.0mV	*OFF		
Width	100.0ns	Amplit	1.00V	ON		
LeadE	5.00ns	50Ω into	50.0Ω			
Traie	=LeadE					
MODE/TRG		OUTPUT		LIMITS		TRG-LEV

Press the **OUTPUT** softkey to access this screen.

In the left part of this screen, you can set up the timing for the signal (period, pulse width, transition times, ...). The right part is for the levels (normal or inverted signal, offset and amplitude, impedance, ...).

Furthermore, you can switch on and off the output.

Pressing **SHIFT + MORE (GRAPH)** when the Output screen is displayed, toggles between the textual display and a graphical representation of the parameters. Depending on the current cursor position (left or right part), the timing parameters or the level parameters are visualized.

Per 1.000µs Normal				OFF	1	<input type="radio"/> MODIFY
Delay	0ps	Offset	+0.0mV	*OFF		
Width	100.0ns	Amplit	1.00V	ON		
LeadE	5.00ns	50Ω into	50.0Ω			
Traie	=LeadE					
MODE/TRG		OUTPUT		LIMITS		TRG-LEV

1	OFF	PERIOD	
		1.000	
		µs	
MODE/TRG		TRG-LEV	

1	OFF	+11V	Output 1
		-11V	*OFF
			ON
MODE/TRG		TRG-LEV	

Adjusting Parameters

Adjusting parameters within a screen, requires two steps:

- selecting the parameter
- adjusting its value

Some parameters allow different formats of their values. For example, the pulse width can be displayed and entered as an absolute value, as duty cycle (percentage of the period), or as the delay of the trailing edge.

The following sections show the standard procedure for adjusting parameters, and list some features useful for the advanced user.

Standard Procedure

To experience the standard procedure for adjusting parameters, consider the following example where the duty cycle is set to 50%.

- 1 Press the OUTPUT softkey to access the Output screen.
- 2 Use the cursor keys to select the WIDTH parameter.

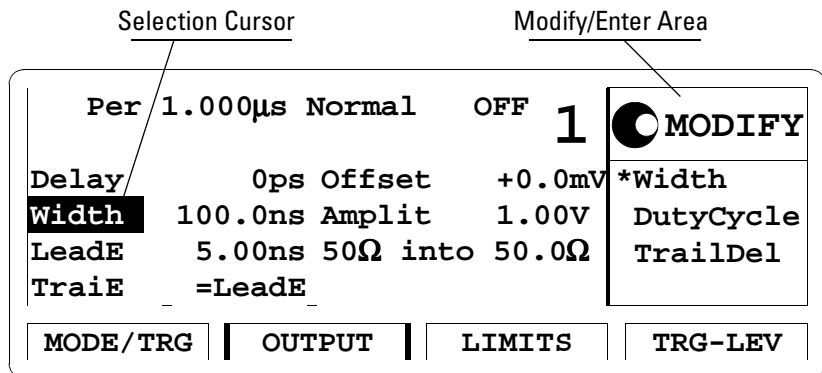

The available formats for the pulse width parameter are displayed in the Modify/Enter area.

Operating the Agilent 81101A

When changing the parameter format, the instrument automatically recalculates the value.

- 3 Turn the knob to select DUTYCYCLE.
The selected setting is indicated by an “*”.
- 4 Move the cursor to the right to select the duty cycle value.
- 5 Use the data entry keys or the knob to enter the required value: 50.
- 6 Press the ENTER key to confirm your selection.

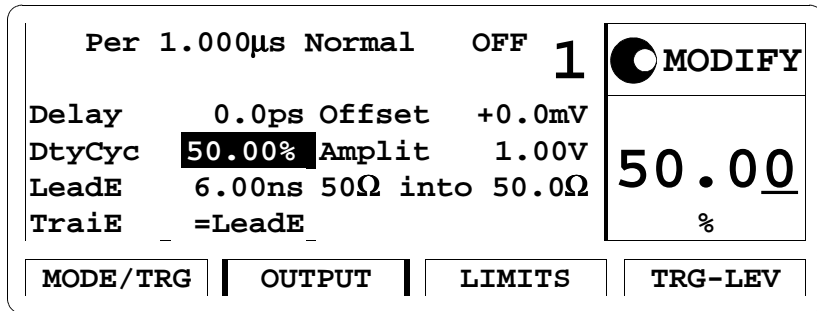

If you need to specify a unit for a parameter, simply press the appropriate unit key (NANO, MICRO/MEGA, MILLI/KILO) instead of the ENTER key.

With this small example, you have learned the basic steps required for adjusting parameters. For a complete reference of parameters and formats available in the individual screens, refer to [Chapter 3 “Using the Agilent 81101A” on page 43](#).

Advanced Procedures

The following features can be used to make operation more comfortable.



- **Selecting parameters**

Most keys of the front panel have an additional function. The SHIFT key provides fast access to the additional functions of the data entry keys and the special function keys.

For example, it is possible to quickly access the pulse width parameter by pressing SHIFT + 6 (WIDTH). The entry focus will be positioned on the corresponding editing field.



- **Changing the step size**

When modifying a value in the Modify/Enter area, pressing the SHIFT key followed by cursor left/right moves the cursor to a different digit in the displayed number.

Thus, you can change the step size for parameter change before you vary the value either with the up/down cursor keys or the knob.

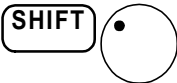

- **Overprogramming**

Pressing the SHIFT key while turning the knob, it is possible to exceed specified parameter ranges to utilize the instrument to its limits.

NOTE

Proper operation of the instrument outside of the specified ranges is not guaranteed. It is recommended to have the output switched on when overprogramming to have the internal error check system activated. This error check system warns you about impossible settings.

Switching the Output On and Off

When you switch the instrument on, the output is switched off to protect the device under test. The LED indicator next to the output connector indicates the output state.

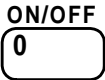

To switch the output on or off

- either press SHIFT + 0 (ON/OFF),
- or move the cursor to the ON/OFF parameter in the Output screen and select the appropriate value by turning the knob.

Using the Special Function Keys

The instrument provides the following special function keys:



- The MAN key can be used in triggered or gated mode to manually trigger the instrument if there is no other source available (see *"The Mode/Trigger Screen" on page 44*).



- The STORE key can be used to store/recall to/from 1 to 9 individual settings in the instrument memory.
In the internal memory location 0 there is a default setting stored. Pressing SHIFT + STORE (RECALL) and selecting 0 resets the instrument to the default setting.



- The SHIFT key provides fast access to additional functions.
When the front panel controls are locked in remote control, pressing the SHIFT key unlocks the front panel controls.



- The HELP key provides access to the instrument's on-line help or in warning or error state, access to Warning/Error Report screen.
Pressing SHIFT + HELP (AUTOSSET) sets the instrument to a valid setting based on the current period setting.

Help is Available

Whenever you are in doubt or the instrument signals warnings or errors, press the HELP key.

Help

If there are *no warnings or errors* pending, pressing the HELP key displays information on the currently selected parameter, the parameter help. More information is available within the help system:

- **Parameter Help**

The help information gives a short description of the parameter or setting options and the corresponding SCPI command(s) syntax for programming the parameter or setting.

If there is more than one screen available (indicated by small arrows), use the knob or the cursor keys to scroll through the help information.

To access parameter help from other screens of the help system, press the ON FIELD softkey.

- **Concept Help**

Pressing the CONCEPT softkey within the help system displays a short description of the instrument.

- **Serial Numbers and Software Revision**

Pressing the SERIAL # softkey within the help system displays information on serial numbers and software revision codes of the instrument.

Warnings and Errors

If there are *warnings or errors* pending (indicated by a flushing W or E), pressing the HELP key displays a list of the current messages. Using the ERROR QU and WARNING softkeys, you can toggle between both lists. For more information on warnings and errors, see [“Warnings and Errors” on page 72](#).

Exit Help

To exit from the help system, press the HELP key again, or press the EXIT HELP softkey.

The Rear Panel

The rear panel always provides two connectors:

- The input connector for external frequency reference (CLOCK/REF INP.). This input can be used if a higher frequency accuracy is required, or if you need frequency locking.
- The GP-IB connector providing the interface for remote control.

The following figure shows the rear panel view with the option UN2.

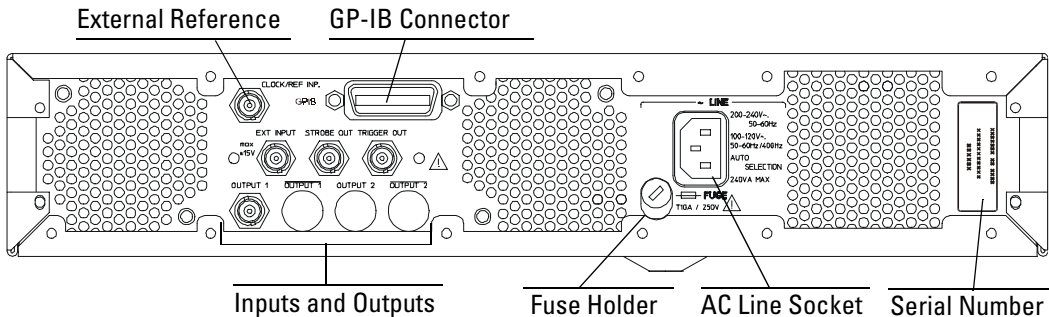

With option UN2 the major inputs and outputs of the instrument (as described in *“The Front Panel” on page 18*) are available at the rear panel:

- external input (EXT INPUT)
- strobe output (STROBE OUT)
- trigger signal (TRIGGER OUT)
- signal output (OUTPUT)

2 Getting Started

The intention of this chapter is to give the necessary steps to set up generic signals for first-time users of the Agilent 81101A.

This chapter provides examples for the following types of signals:

- *“Setting Up a Clock Signal” on page 30*
- *“Setting Up a Pulse Signal” on page 35*
- *“Setting Up a Burst Signal” on page 39*

At the end of each example, the required set of device commands is listed to provide programming examples. For further information on the commands and a complete command reference please refer to the *Reference Guide*, p/n 81101-91021.

The examples are intended to be performed one after the other. Therefore, the first example provides the most detailed instructions, while the other examples are described on a higher level.

Setting Up a Clock Signal

Task

Set up a continuous clock signal with 25 MHz frequency with PLL accuracy, a duty cycle of 50 %, 6 ns transition times, a high level of 2.5 V and low level of 0 V.

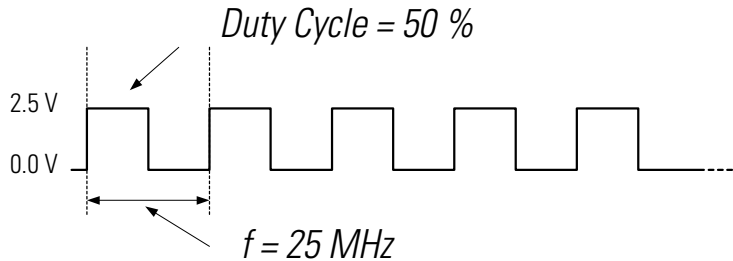

Instructions

To set the **operating mode and trigger mode** as required:

- 1 Reset all parameters and modes by pressing SHIFT + STORE (RECALL) + 0.
- 2 Press the MODE/TRG softkey to enter the Mode/Trigger screen. Trigger mode CONTINUOUS and operating mode PULSES are selected by default.
- 3 Move the entry focus down to PULSE-PERIOD and turn the knob to select INTERNAL PLL.

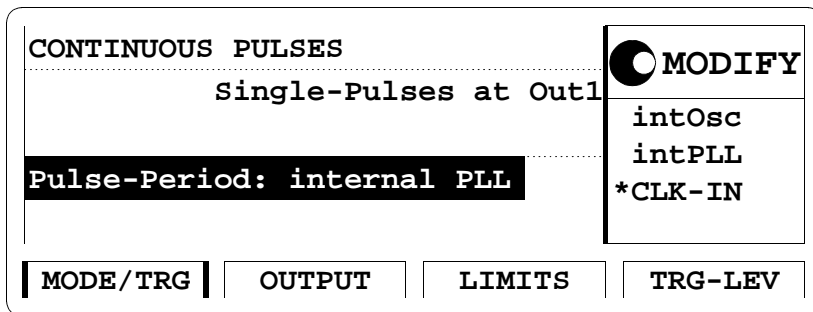

To set the **timing parameters** as required:

- 1 Press the OUTPUT softkey to enter the Output screen.
- 2 Press SHIFT + 0 (ON/OFF).
This turns on the Output and activates the internal error check to detect parameter conflicts.
- 3 Move the entry focus to PER and turn the knob to select FREQ.
- 4 Move the entry focus to the right (to the frequency entry field) and enter a value of 25 MHz by pressing 2 + 5 + MICRO/MEGA.
A warning is displayed, indicating a potential conflict in your settings. You can ignore this, because the conflict will be solved in the next steps.
- 5 Move the entry focus down to WIDTH and select DUTYCYCLE.
- 6 Move the entry focus to the right and enter 50 % by typing 5 + 0 + ENTER.
- 7 Move the entry focus down to the leading edge entry field and press 6 + NANO.
The trailing edge is set to be the same as the leading edge (TRAIÉ = LEADÉ) by default.

Freq	25.00MHz	Normal	ON	1	 MODIFY
Delay	0.0ps	Offset	+0.0mV		
DtyCyc	50.00%	Amplit	1.00V		6.00 <u>ns</u>
LeadE	6.00ns	50Ω into	50.0Ω		
TraiE	=LeadE				
MODE/TRG		OUTPUT		LIMITS	
				TRG-LEV	

- 8 Press SHIFT + MORE (GRAPH) to see a preview of your signal.

Getting Started
Setting Up a Clock Signal

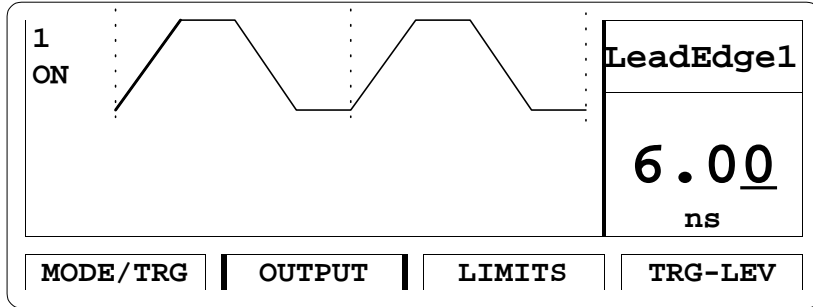

You can modify the parameter displayed in the Modify/Enter area, and immediately check how your changes affect the signal. Use the cursor keys to switch to another parameter.

- 9 Press SHIFT + MORE (GRAPH) to return to the textual screen.

To set the **level parameters** as required:

- 1 Move the entry focus to OFFSET/AMPLITUDE and turn the knob to select HIGH-LOW.
- 2 Move the entry focus to the high level entry field, enter 2.5 and press the ENTER key.

In the same way, enter 0 for the low level. The impedance is 50Ω source into 50Ω load by default.

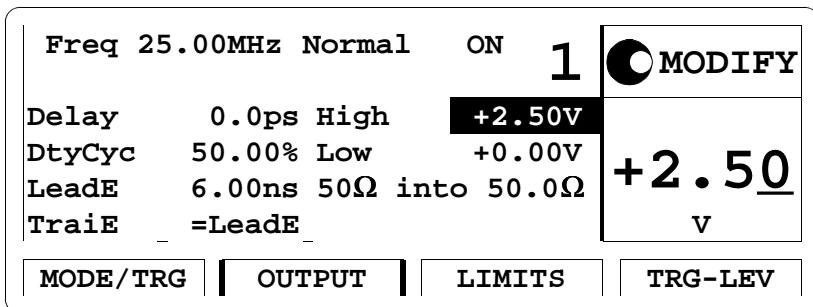

NOTE

There is also a graphical screen available for the level parameters.

Here is the signal as displayed on an Agilent 54810A Infinium oscilloscope. Use the generator's TRIGGER OUT to trigger the scope.

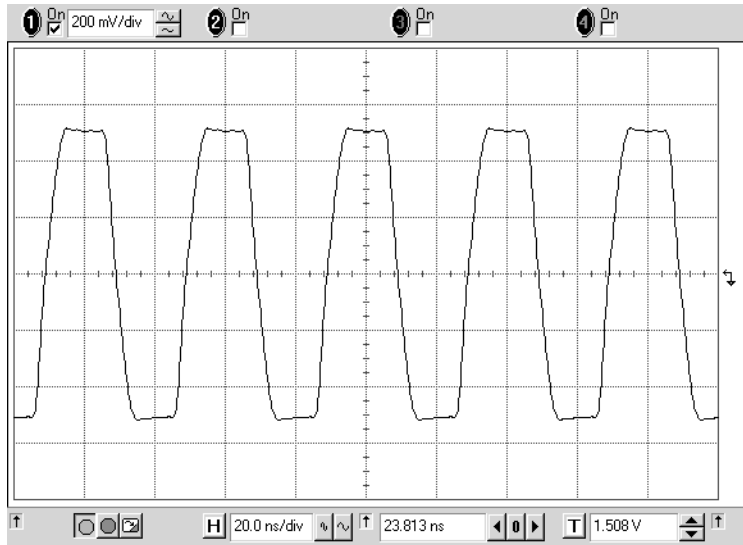

Getting Started

Setting Up a Clock Signal

Programming Example

If you want to include this clock signal in your GP-IB program, use the following command lines. The comment lines starting with a # are not required.

```
# Reset the instrument to start from a defined, default status.
*RST

# Switch off the automatic display update to increase programming
# speed.
:DISPlay OFF

# Internal PLL has to be set as period source.
:ARM:SOURce INT2

# Set the frequency to 25 MHz, the duty cycle to 50 % and the
# leading and trailing edge to 6 ns.
:FREQuency 25 MHZ
:PULSe:DCYCLE 50
:PULSe:TRANSition 6NS

# Set the high level to 2.5 Volts, the low level to 0.0 Volts.
:VOLTage:HIGH 2.5V
:VOLTage:LOW 0V

# Enable the output.
:OUTPut ON
```

Setting Up a Pulse Signal

Task

Set up a continuous pulse signal with 50 ns period, a pulse width of 30 ns, a leading edge of 6 ns, a trailing edge of 10 ns, an amplitude of 3.3 V and an offset of 1.65 V (high level 3.3 V, low level 0.0 V).

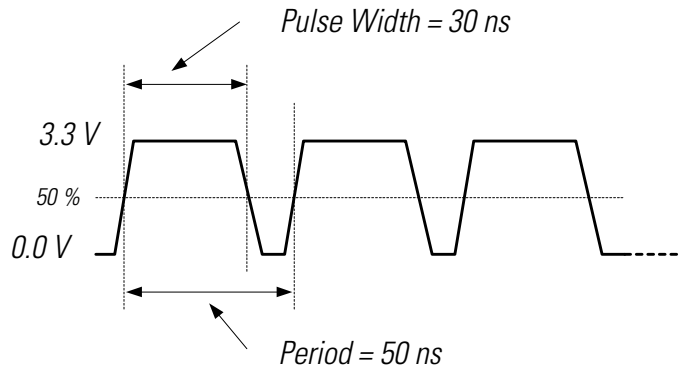

Instructions

To set the **operating mode and trigger mode** as required:

- 1 Reset all parameters and modes by pressing SHIFT + STORE + 0.
- 2 Press the MODE/TRG softkey to enter the Mode/Trigger screen.
The default settings can be used for this example. For reference the Mode/Trigger screen is displayed. There is nothing to change.

CONTINUOUS	PULSES	<input checked="" type="radio"/> MODIFY
Single-Pulses at Out1		*PulseStrm
Pulse-Period: internal Osc		Burst
MODE/TRG	OUTPUT	LIMITS
		TRG-LEV

Getting Started
Setting Up a Pulse Signal

To set the **timing parameters** as required:

- 1 Press the OUTPUT softkey to enter the Output screen.
- 2 Switch on the output.
- 3 Enter a period of 50 NS.
 A warning is shown, which you may ignore, because the parameter conflict will be solved in the next steps.
- 4 Enter a pulse width of 30 NS.
- 5 Enter 6 NS for the leading edge.
- 6 For the trailing edge, select ABSOLUTE and enter a value of 10 NS.

Per 50.00ns Normal ON 1				<input checked="" type="radio"/> MODIFY
Delay	0.0ps	Offset	+0.0mV	10.0 ns
Width	30.00ns	Amplit	1.00V	
LeadE	6.00ns	50Ω into	50.0Ω	
TraiE	10.0ns			
MODE/TRG		OUTPUT		LIMITS
				TRG-LEV

To set the **level parameters** as required:

- 1 Enter an offset of 1.65 V.
- 2 Enter an amplitude of 3.30 V.

Per 50.00ns Normal ON 1				<input checked="" type="radio"/> MODIFY
Delay	0.0ps	Offset	+1.65V	3.30 V
Width	30.00ns	Amplit	3.30V	
LeadE	6.00ns	50Ω into	50.0Ω	
TraiE	10.0ns			
MODE/TRG		OUTPUT		LIMITS
				TRG-LEV

Here is the figure as displayed on the Agilent 54810A Infinium oscilloscope. Use the generator's TRIGGER OUT to trigger the scope.

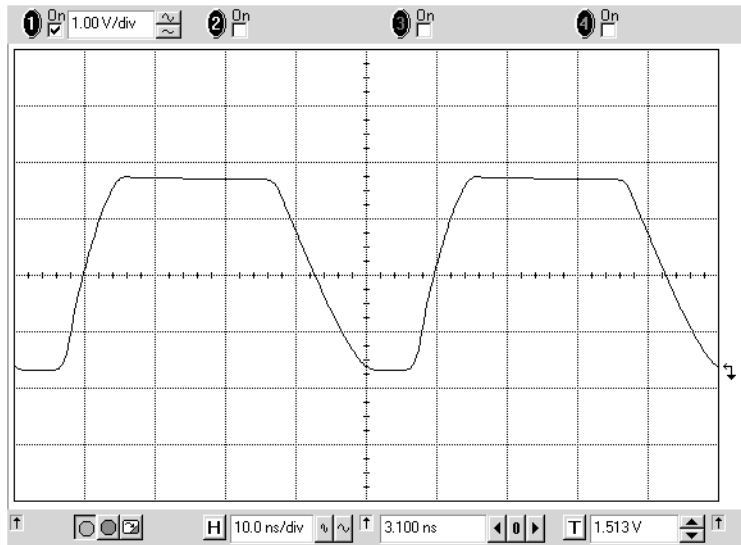

Getting Started

Setting Up a Pulse Signal

Programming Example

If you want to include this pulse signal in your GP-IB program, use the following command lines. The comment lines starting with a # are not required.

```
# Reset the instrument to start from a defined, default status.
*RST

# Switch off the automatic display update to increase programming
# speed.
:DISPlay OFF

# Pulse stream operating mode is required, but as we start
# from a default status it is not necessary to send a command for
# setting the instrument into pulse stream operating mode.
# Set the period to 50 ns, the pulse width to 20 ns, the leading
# edge to 6 ns and the trailing edge to 10 ns.
:PULSe:PERiod 50NS
:PULSe:WIDTh 30NS
:PULSe:TRANSition 6NS
:PULSe:TRANSition:TRAILing:AUTO OFF
:PULSe:TRANSition:TRAILing 10NS

# Set the amplitude to 3.3 Volts, the offset to 1.65 Volts.
:VOLTage 3.3V
:VOLTage:OFFSet 1.65V

# Enable the output
:OUTPut ON
```

Setting Up a Burst Signal

Task

Set up a burst signal with a burst repetition of $2\ \mu\text{s}$. Each burst consists of two double-pulses at a period of $500\ \text{ns}$. The pulse width is $100\ \text{ns}$, the delay between the two pulses of a double-pulse is $200\ \text{ns}$. The levels are $2\ \text{Vpp}$ amplitude and $0\ \text{V}$ offset.

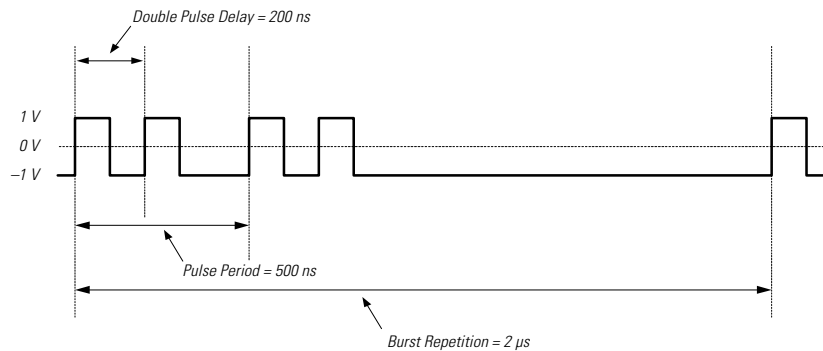

Instructions

To set the **operating mode and trigger mode** as required:

- 1 Reset all parameters and modes by pressing **SHIFT + STORE + 0**.
- 2 Press the **MODE/TRG** softkey to enter the Mode/Trigger screen.
The internal PLL is used to trigger the startable internal oscillator. The PLL defines the burst repetition, the oscillator generates the pulse period. This requires the following settings:
- 3 Move to **CONTINUOUS** and turn the knob to select **TRIGGERED**.
- 4 Move to **PULSES** and select **BURST**.
- 5 Move down and select **DOUBLE (DOUBLE-PULSES AT OUT 1)**.
- 6 Move left and select a burst length of **2**.
- 7 Move down and select **TRG'D BY: PLL** and set the period to $2.000\ \mu\text{s}$ (burst repetition).

Getting Started
Setting Up a Burst Signal

TRIGGERED BURSTS OF		<input checked="" type="radio"/> MODIFY	
2-Double-Pulses at Out1			
Pulse-Period: internal Osc		2.000 μ s	
Trg'd by: PLL -> Per 2.000 μ s			
MODE/TRG	OUTPUT	LIMITS	TRG-LEV

To set the **timing parameters** as required:

- 1 Press the OUTPUT softkey to enter the Output menu.
- 2 Switch on the Output.
- 3 Enter a pulse period of 500 NS.
- 4 Enter a double-pulse delay (DBLDEL) of 200 NS.

To set the **level parameters** as required:

- 1 Enter an amplitude of 2.00 V.

Per 500.0ns Normal		ON	1	<input checked="" type="radio"/> MODIFY
Dbldel	200.0ns	Offset	+0.0mV	
Width	100.0ns	Amplit	2.00V	2.00 V
LeadE	5.00ns	50 Ω	into 50.0 Ω	
TraiE	=LeadE			
MODE/TRG	OUTPUT	LIMITS	TRG-LEV	

The following figure shows the signals as displayed on the Agilent 54810A Infinium Oscilloscope if you connect OUTPUT to channel 1, STROBE OUT to channel 2, and use the generator's TRIGGER OUT to trigger the scope.

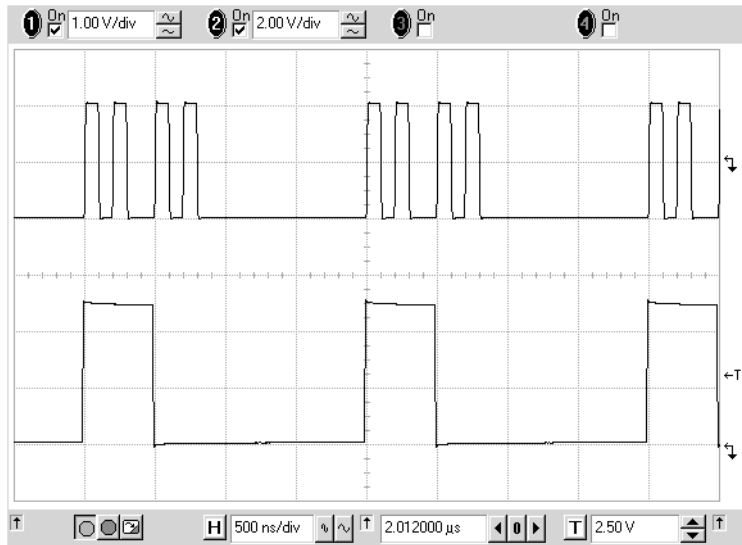

Getting Started

Setting Up a Burst Signal

Programming example

If you want to include this burst signal in your GP-IB program use the following command lines. The comment lines starting with a # are not required.

```
# Reset the instrument to start from a defined, default status.
*RST

# Switch off the automatic display update to increase programming
# speed.
:DISPlay OFF

# Set the instrument to burst mode by selecting a burst count
# of 2. Choose double pulses. Select triggered mode by selecting
# PLL as the trigger source and set the burst repetition to 2  $\mu$ s.
:TRIGger:COUNT 2 # Set Burst mode with burst count of 2
:ARM:SOURce INT2 # Set Triggered mode with PLL as
# trigger source
:ARM:PERiod 2US # Set burst repetition of 2  $\mu$ s
:PULSe:DOUBLE ON # second channel generates double pulses
# per period

# Set the double pulse delay to 200 ns and the width to 100 ns.
:PULSe:PERiod 500NS
:PULSe:WIDTh 100NS
:PULSe:DOUBLE:DELAy 200NS

# Set the output amplitude to 2 Volts and the offset to
# 0.0 Volts.
:VOLTagE 2V

# Enable the output.
:OUTPut ON
```

3

Using the Agilent 81101A

This chapter provides complete reference information for using the Agilent 81101A by means of the user interface screens.

Each screen is described in detail. To access the individual screens, use the softkeys below the screen. There are two softkey layouts:

- the default layout



- the alternative layout displayed after pressing the MORE key



At the end of this chapter, *“Warnings and Errors” on page 72* provides details on the instrument’s warning and error messaging system.

NOTE

For general information on using the Agilent 81101A and information on the instrument’s hardkeys, please refer to *Chapter 1 “Introducing the Agilent 81101A Pulse Generator” on page 15*.

NOTE

For information on using the Agilent 81101A via remote control, please refer to the *Reference Guide*, part number 81101-91021.

The Mode/Trigger Screen

This section describes the Mode/Trigger screen, starting with an overview of the available parameter combinations, followed by detailed descriptions of each combination.

Overview

To access the Mode/Trigger screen, press the MODE/TRG softkey.

The following figure shows a typical Mode/Trigger screen, where the individual parameters are indicated. The parameter combinations are listed in the table on the next page.

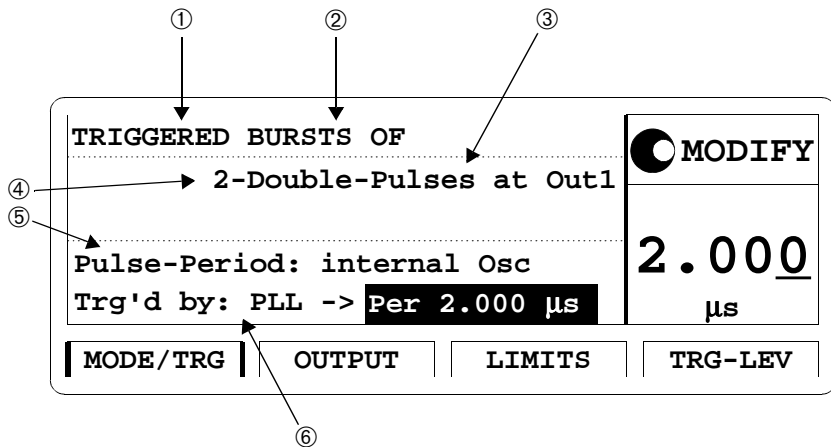

In this screen, you can set up the signal to be triggered or continuous, and to be a pulse stream or a burst (several pulses followed by a pause) consisting of single or double pulses.

Furthermore, you can specify the pulse and trigger sources.

The following table provides a list of possible parameter combinations. The rows refer to the numbers in the figure.

① Trigger Mode	Continuous		Triggered		Gated		Ext. Width
② Pulse Mode	Pulses	Burst	Pulses	Burst	Pulses	Burst	
③ Pulse Type	Single/Double		Single/Double		Single/Double		
④ Length		2-65536		2-65536		2-65536	
⑤ Period Source	internal Osc. internal PLL CLK-IN			internal Osc. internal PLL CLK-IN	internal Osc. internal PLL CLK-IN		
⑥ Arming Source			MAN key Ext. Input	MAN key Ext. Input PLL	MAN key Ext. Input		MAN key Ext. Input
Trigger Out	marks each pulse period generated						
Strobe Out	not used	↑ on 1st ↓ on last	not used	↑ on 1st ↓ on last	not used	↑ on 1st ↓ on last	not used

The pulse period source can be selected from internal oscillator, internal PLL, and external CLK-IN:

- If you have to trigger after an external event, use the startable oscillator (**internal Osc.**), which starts on the external signal with a fixed latency.
- If you do not have to trigger but need a high accuracy frequency, then use the **internal PLL** clock generation circuitry.
- For even more accuracy, you can use the external CLK-IN.

In triggered/gated mode the internal PLL can be used as an arming source. However, the internal PLL cannot be used as pulse and arming source at the same time.

The following sections explain the individual mode combinations in more detail. For each combination of trigger mode and pulse mode, typical timing diagrams are provided, showing single and double pulses.

Continuous Pulses Mode

The following figure shows typical timings for trigger mode CONTINUOUS and pulse mode PULSES.

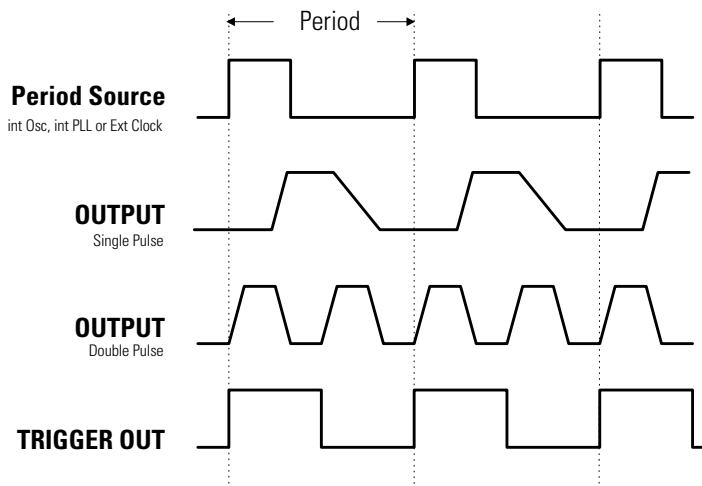

Characteristics

- Pulse periods are generated continuously.
- You can select single pulses or double pulses per pulse period.
- For the pulse period source you can select from
 - internal Osc (VFO)
 - internal PLL (higher accuracy)
 - external CLK-IN (external signal), synchronize to rising or falling edge
- TRIGGER OUT marks each pulse period.

NOTE

STROBE OUT is not used in continuous pulse mode.

Continuous Burst Mode

The following figure shows typical timings for trigger mode CONTINUOUS and pulse mode BURST.

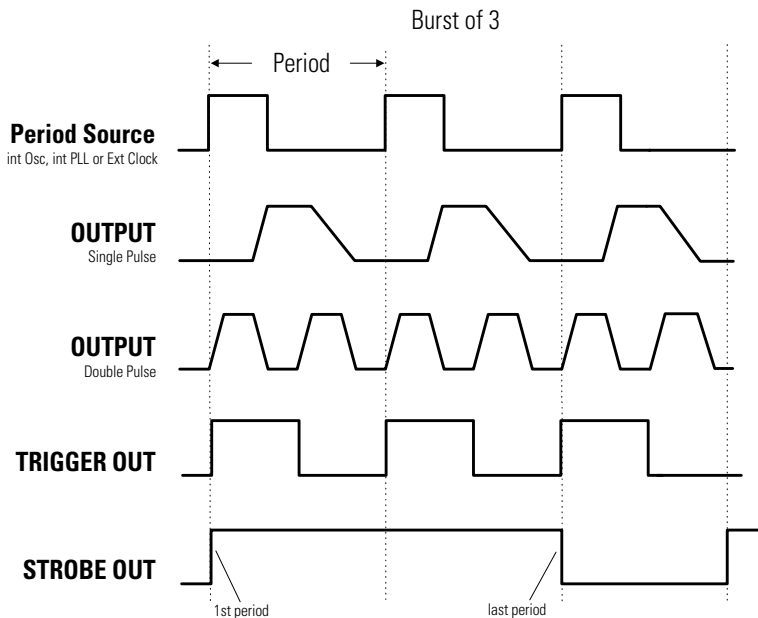

Characteristics

- A burst of pulse periods is repeated continuously.
- You can select the number of pulse periods per burst in the range of 2–65536.
- You can select single pulses or double pulses per pulse period.
- For the pulse period source you can select from
 - internal Osc (VFO)
 - internal PLL (higher accuracy)
 - external CLK-IN, synchronize to rising or falling edge.
- TRIGGER OUT marks each pulse period.
- STROBE OUT rises at the start of the first pulse period in a burst, and falls at the start of the last pulse period.

Triggered Pulses Mode

The following figure shows typical timings for trigger mode TRIGGERED and pulse mode PULSES. The pulses are triggered by the rising edge of the arming source.

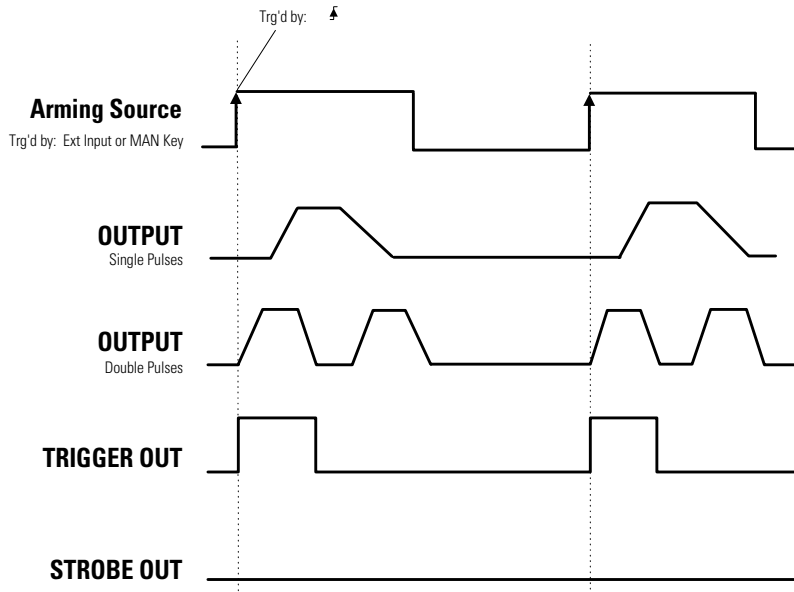

Characteristics

- Single pulse periods are triggered by (TRG'D BY) an active edge at the selected arming source:
 - MAN key on front panel, triggered by press or release or both.
 - EXT INPUT triggered by rising or falling or both edges.
- You can select single pulses or double pulses per pulse period.
- TRIGGER OUT marks each pulse period.
- STROBE OUT is not used in triggered pulse mode.

NOTE

The PLL *cannot* be selected as the arming source. Select continuous pulse mode with the PLL as period source to achieve the same result.

In contrast to the previous figure, this figure shows a timing diagram where the pulses are triggered by both rising and falling edges of the arming source.

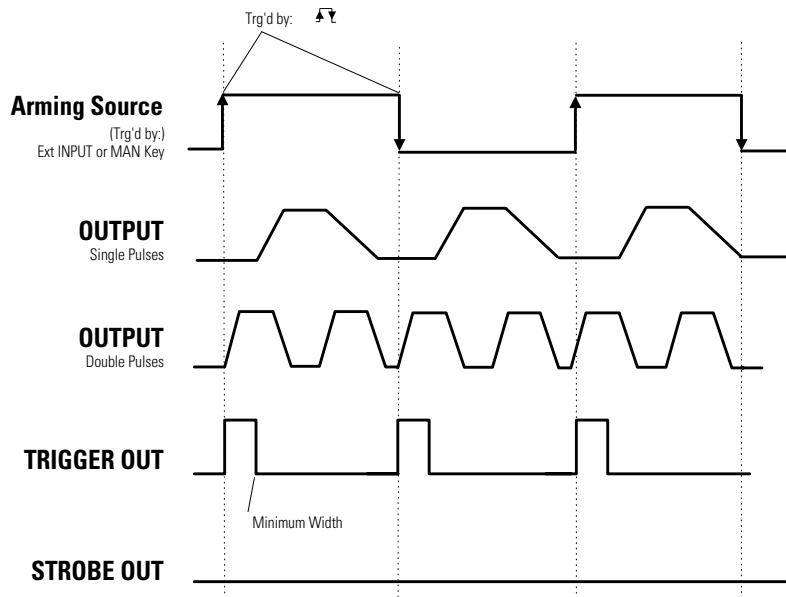

Triggered Burst Mode

The following figures show typical timings for trigger mode TRIGGERED and pulse mode BURST. The bursts are triggered by the rising edge of the arming source.

For the first example, the *synchronously triggerable* internal oscillator is used to source the period.

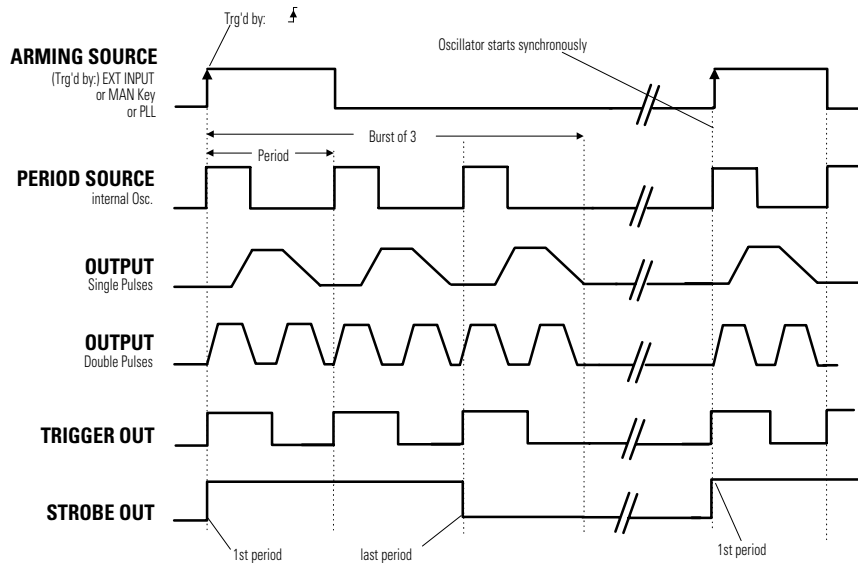

Characteristics

- A burst of pulse periods is triggered by an active edge at the selected arming source
 - MAN key on front panel, triggered by press or release or both.
 - EXT INPUT triggered by rising or falling or both edges.
 - PLL (internally triggered bursts)

When using the internal PLL as the arming source, you must specify the triggering period.

- You can select the number of pulse periods per burst in the range of 2–65536.
- You can select single pulses or double pulses per pulse period.

- TRIGGER OUT marks each pulse period.
- STROBE OUT rises at the start of the first pulse period in a burst and falls at the start of the last pulse period.

For the second example, either the internal PLL or an external CLK-IN are used to source the period—both cannot be triggered synchronously.

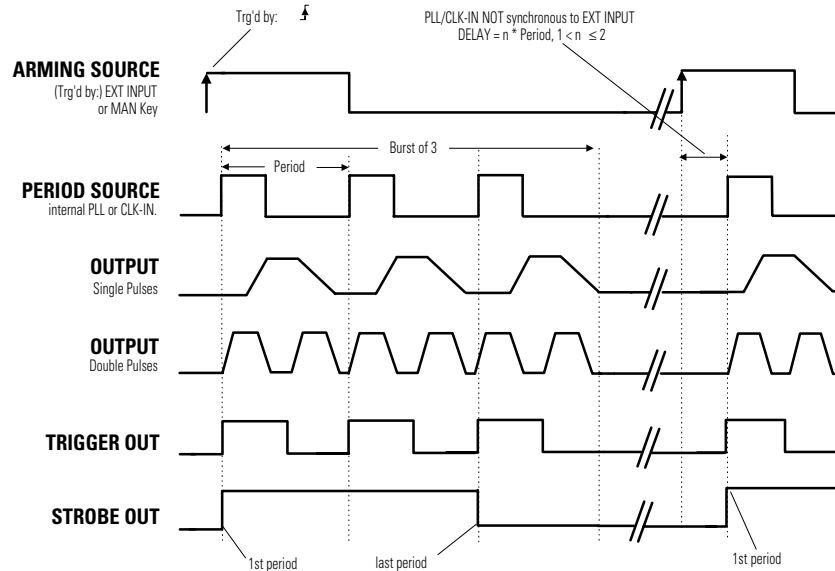

NOTE

You cannot use the PLL as both pulse period source and arming (TRG'D BY) source at the same time.

Gated Pulses Mode

The following figures show typical timings for trigger mode GATED and pulse mode PULSES.

For the first example, the *synchronously triggerable* internal oscillator is used to source the period.

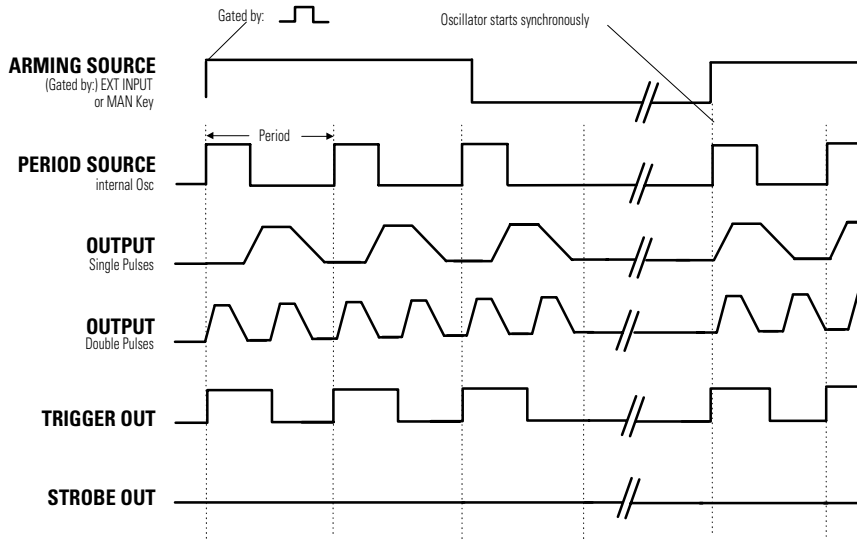

Characteristics

- Pulse periods are gated by (enabled by) an active level at the selected arming source:
 - MAN key on the front panel, gated while pressed or released or both.
 - EXT INPUT (external signal) gated by high, low or both levels.
- You can select single pulses or double pulses per pulse period.
- TRIGGER OUT marks each pulse period.
- STROBE OUT is not used in gated pulses mode.

For the second example, either the internal PLL or an external CLK-IN are used to source the period—both cannot be triggered synchronously.

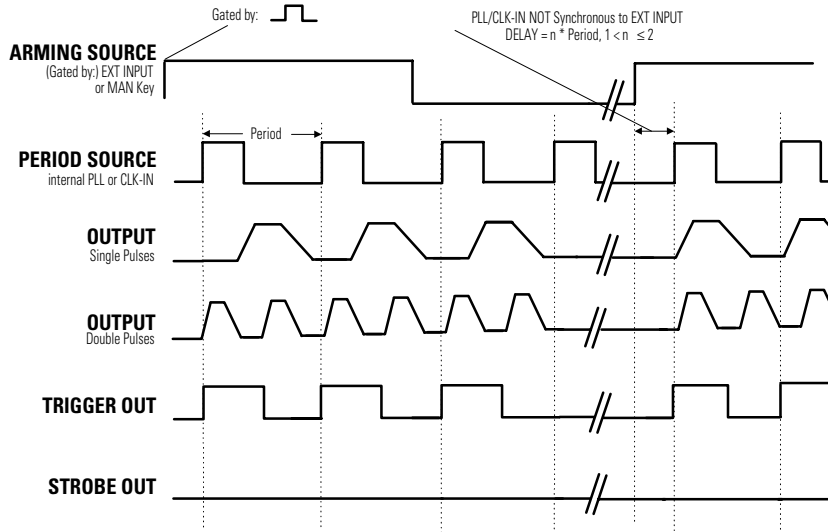

Gated Burst Mode

The following figures show typical timings for trigger mode GATED and pulse mode BURST.

For the first example, the *synchronously triggerable* internal oscillator is used to source the period.

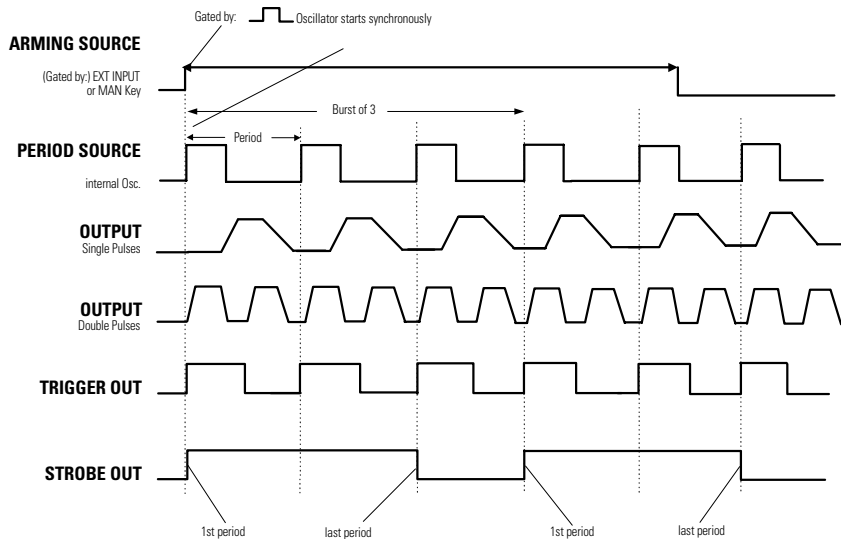

Characteristics

- Bursts of pulse periods are gated by (enabled by) an active level at the selected arming source:
 - MAN key on the front panel, gated while pressed or released or both.
 - EXT INPUT (external signal) gated by high, low or both levels.
- You can select single pulses or double pulses per pulse period.
- TRIGGER OUT marks each pulse period.
- STROBE OUT rises at the start of the first pulse period in a burst and falls at the start of the last pulse period.

For the second example, either the internal PLL or an external CLK-IN are used to source the period—both cannot be triggered synchronously.

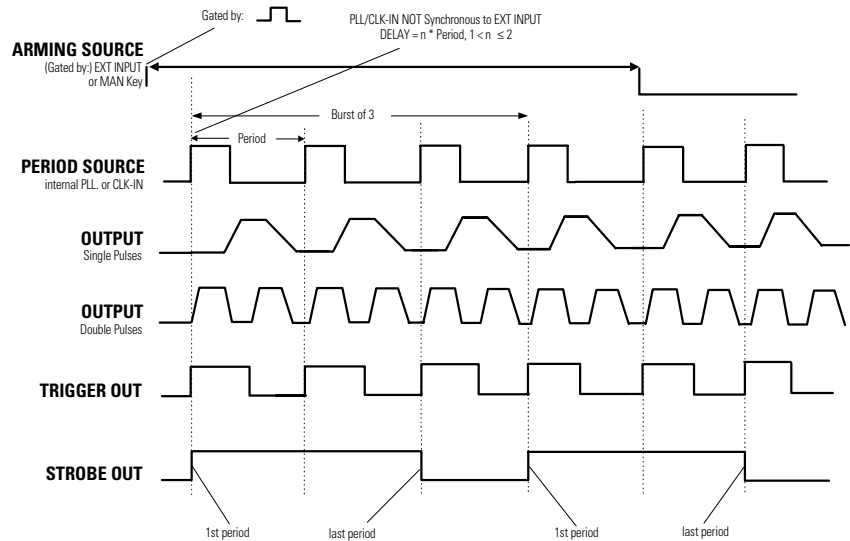

External Width Mode

In external width mode, the pulse width is determined by an external signal. You can choose between:

- **MANKEY:** Pressing the key generates a leading edge, releasing the key generates a trailing edge.
- **EXT-IN:** A rising edge at the EXT INPUT generates a leading edge, a falling edge generates a trailing edge.

The threshold and impedance of the EXT INPUT can be set on the Trigger Level screen.

The period, delay, and width of the output pulse are not programmable in this mode, because they are determined by the external signal.

The TRIGGER OUT rises and falls parallel to the OUTPUT signal.

The Output Screen

The Output screen shows both timing and level parameters on one screen.

To access the Output screen, press the OUTPUT softkey.

Timing Parameters

You can use the left part of the Output screen to view and control the pulse timing parameters.

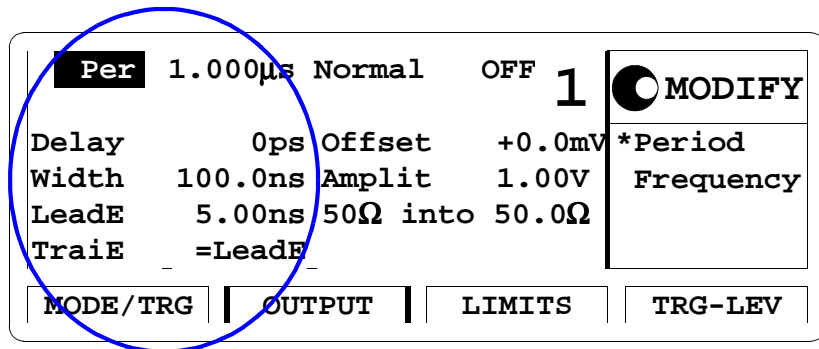

The individual timing parameters are described in more detail in the following. All parameters can be entered in different formats.

NOTE

With the Agilent 81101A you can vary timing parameters without the risk of glitches or drop outs, which could cause measurement errors. This applies to continuous mode with timing values < 100 ms (frequency < 10 Hz), and consecutive values between one-half and twice the previous value.

When you press SHIFT + MORE (GRAPH) while one of the timing parameters is selected, you will see a graphical representation of the timing parameters. The currently selected parameter is displayed in the Modify/Enter area and is indicated by dashed or bold lines in the graphical display.

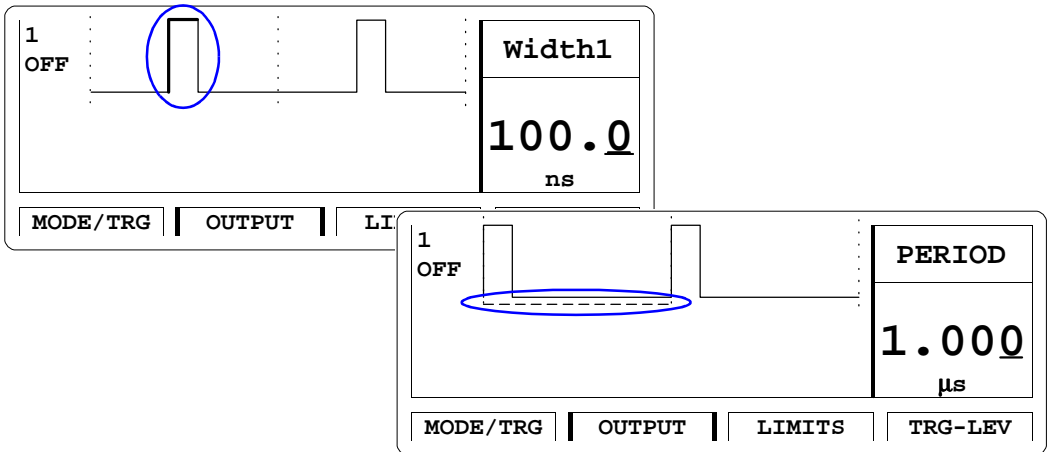

Use the left/right cursor keys to toggle between the individual timing parameters.

NOTE

Note that in graphics mode you can only adjust the *values* of each parameter, not the parameter format. If you want to change the format of a parameter, for example WIDTH to DTYCYC, you must be in text mode to select the parameter name with the cursor.

Pulse Period Parameter

Set the pulse period as either PERIOD or FREQUENCY.

If you select the CLK-IN as the pulse period source on the Mode/Trigger screen, the pulse period/frequency is determined from the signal applied to the CLOCK/REF INP. connector:

- MEAS ONCE

The external signal is measured only once. Press ENTER to measure again.

- **MEAS CONT**

The external signal is continuously measured until the instrument receives a command via GP-IB.

To invoke continuous measurements again, you have to bring the instrument in local operating mode by pressing SHIFT (LOCAL) and start continuous measurement again.

Pulse Delay Parameter

Delay the leading edge of the pulse within the pulse period. There are three delay formats available:

- **DELAY** or **DBLDEL** (select **ABSOLUTE**)

DELAY is the absolute delay from the start of a pulse period to the start of the leading edge of the pulse.

If double pulses are selected on the Mode/Trigger screen, the **DBLDEL** parameter specifies the delay between the first and second pulse in each pulse period.

The absolute delay is independent of the pulse period. So the leading edge does not move relative to the start of the period if you change the period.

- **DELAY%** (select **% OF PERIOD**)

The delay from the start of the pulse period to the start of the leading edge expressed as a percentage of the pulse period. In this format, if you change the period, the leading edge moves relative to the start of the period in order to maintain the percentage delay.

- **PHASE** (select **PHASE**)

The phase delay in degrees from the start of the pulse period to the start of the leading edge ($360^\circ = 1$ pulse period). In this format, if you change the period, the leading edge moves relative to the start of the period in order to maintain the phase delay.

Pulse Width Parameter

Set the width of the output pulse. There are three width formats available:

- **WIDTH** (select WIDTH)
The absolute pulse width measured from the start of the leading edge to the start of the trailing edge. In this format, the pulse width is independent of changes in pulse period and delay.
- **DTYCYC** (select DUTYCYCLE)
The duty cycle is the pulse width measured from the start of the leading edge to the start of the trailing edge expressed as a percentage of the period. In this format, if you adjust the period, the absolute width is adjusted to maintain the duty cycle.
- **TRADEL** (select TRAILDEL)
The trailing delay is the absolute delay from the start of the pulse-period to the start of the trailing edge. In this format the trailing edge remains fixed relative to the start of the pulse period if you adjust the pulse delay (leading edge delay) or the pulse period.

NOTE

You cannot have the width format set to DTYCYC and the leading/trailing-edge format set to percentage of width (LEADED%/TRAILE%) at the same time.

Leading Edge Parameter

Set the leading edge transition time of the pulse, measured from 10% to 90% of the pulse amplitude. There are two formats available:

- **LEADE** (select ABSOLUTE)
The absolute transition time measured from 10% to 90% of the pulse amplitude. In this format the leading edge is independent of the pulse width.
- **LEADE%** (select % OF WID)
The absolute transition time expressed as a percentage of the pulse width. In this format, if you adjust the pulse width, the transition time is adjusted to maintain the edge time as a percentage of the width.

NOTE The leading and trailing edges are independently programmable within certain ranges only, see “*Transition Times*” in the *Reference Guide*.

NOTE You cannot have the width format set to DTYCYC and the leading/trailing-edge format set to percentage of width (LEADE%/TRAIE%) at the same time.

Pulse Trailing Edge Parameter

Set the trailing edge transition-time of the pulse, measured from 10% to 90% of the pulse amplitude. There are three formats available:

- =LEADE (select =LEADE)
The trailing edge transition time is coupled directly to the leading edge to maintain a symmetrical pulse.
- TRAIE (select ABSOLUTE)
The absolute transition time measured from 90% to 10% of the pulse amplitude. In this format the trailing edge is independent of the leading edge and the pulse width.
- TRAIE% (select % OF WID)
The trailing edge transition time expressed as a percentage of the pulse width. In this format, if you adjust the pulse width, the transition time is adjusted to maintain the edge time as a percentage of the width.

NOTE The leading and trailing edges are independently programmable within certain ranges only, see “*Transition Times*” in the *Reference Guide*.

NOTE You cannot have the width format set to DTYCYC and the leading/trailing edge format set to percentage of width (LEADE%/TRAIE%) at the same time.

Level Parameters

You can use the right part of the Output screen to view and control the pulse level parameters and to enable or disable the outputs.

Per 1.000μs	Normal	OFF	1	<input type="radio"/> MODIFY
Delay	0ps	Offset	+0.0mV	*OFF
Width	100.0ns	Amplit	1.00V	ON
LeaE	5.00ns	50Ω into	50.0Ω	
TraIE	=LeaE			

MODE/TRG | OUTPUT | LIMITS | TRG-LEV

The individual level parameters are described in more detail in the following. All parameters can be entered in different formats.

When you press SHIFT + MORE (GRAPH) while one of the level parameters is selected, you will see a graphical representation of the level parameters. The currently selected parameter is displayed in the Modify/Enter area and is indicated in the graphical display.

1 OFF	+11V	Amplitude1
	↕	1.00
	-11V	v

MODE/TRG | OUTPUT | LIMITS | TRG-LEV

When output limits are on, the limits are indicated on the Output screen in graphics mode (see *“The Limits Screen” on page 64*).

The Output Screen

NOTE Note that in graphics mode you can only adjust the *values* of each parameter, not the parameter format. If you want to change the format of a parameter, for example OFFS-AMPL to HIGH-LOW, you must be in text mode to select the parameter name with the cursor.

NOTE When the output is switched on, the instrument monitors the actual voltage and current levels at the output. The output is automatically switched off if voltage levels or power dissipation reach levels which could damage the output circuits.

Normal/Complement Parameter

Switch the output between normal and complement mode:

- NORMAL
Pulse leading edge rises from low to high level, trailing edge falls from high to low level.
- COMPLMNT
Pulse leading edge falls from high to low level, trailing edge rises from low to high level.

NOTE This parameter is only available in text mode.

Offset/Amplitude, High/Low Level Parameters

Set and display the pulse levels in terms of either offset and amplitude, or high and low level. You can quickly set TTL or ECL output levels using the SET TTL and SET ECL formats.

- SET TTL
Select high and low level formats and automatically set the levels to the default TTL levels:
TTL-HI: +2.50 V
TTL-LOW: +0.0 mV
The default levels are set once and can be adjusted afterwards by moving the entry focus to the values as normal.
- HIGH-LOW
Select high and low level format for the pulse levels.

- **OFFS-AMPL**

Select offset and amplitude format for the pulse levels. Offset is measured from 0V to the middle of the pulse amplitude. Pulse amplitude is the difference between the high and low levels of the pulse.

- **SET ECL**

Select high and low level format and automatically set the levels to the default ECL levels:

ECL-HI: -850 mV

ECL-LOW: -1.80 V

These default levels are set once and can be adjusted afterwards by moving the entry focus to the value as normal.

Voltage/Current Mode (mV/V/mA/A)

Move the entry focus onto the level units to select between setting the pulse levels IN VOLTS or IN AMPERES.

NOTE

This parameter is only available in text mode.

Output Source Impedance Parameter (50Ω into)

Select an output source impedance of 50 Ω or 1 kΩ

NOTE

This parameter is only available in text mode

Load Impedance Parameter (50.0Ω)

Adjust the load impedance value expected at the output to compensate for non-50Ω loads. The displayed level parameters are then calculated using this value and therefore represent the levels at a non-50Ω static load.

NOTE

This parameter is only available in text mode.

The Limits Screen

Use the Limits screen to set up voltage and current limits for the pulse level parameters to prevent accidental damage of the device under test.

To access the Limit screen, press the LIMIT softkey.

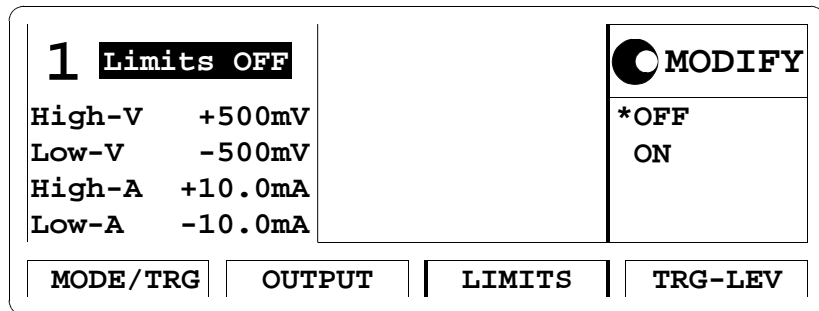

After you switch on the limits, the pulse level parameters on the OUTPUT screen cannot be adjusted outside the ranges specified on the LIMITS screen if the output is switched on. Note that because current and voltage limits apply, the available ranges of the impedance parameters are also affected.

When output limits are on, the limits are indicated on the OUTPUT screen in graphics mode, and the level bar is scaled accordingly:

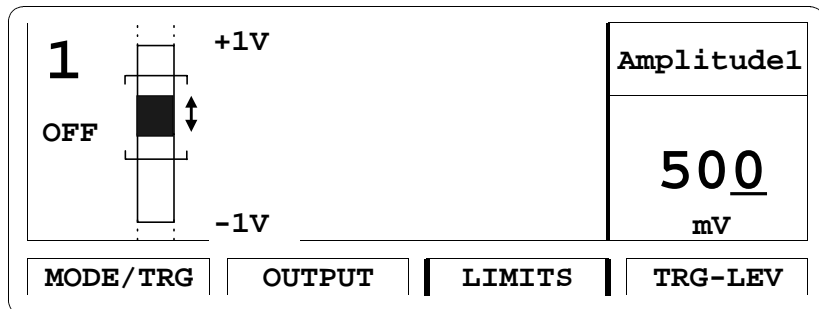

The Trigger-Level Screen

Use the Trigger-Level screen to

- set the triggering threshold and input impedance for the EXT INPUT connector,
- set the triggering threshold and input impedance for the CLOCK/REF INP. connector,
- set the output levels for the STROBE OUT and TRIGGER OUT connectors.

To access the Trigger-Level screen, press the TRG-LEV softkey.

EXT-IN: Threshold	+1.0V 50Ω	 MODIFY	
CLK-IN: Threshold	+1.0V 50Ω		
TRIGGER-OUT: TTL		Set TTL	
STROBE-OUT : TTL		Set ECL	
		*Voltage	
MODE/TRG	OUTPUT	LIMITS	TRG-LEV

Threshold and Impedance Parameters

You can individually specify threshold and input impedance of the EXT-IN and the CLK-IN connectors.

EXT-IN and CLK-IN Threshold Parameters

Move the entry focus to EXT-IN or CLK-IN to quickly set the triggering threshold of the external input or the clock input to a TTL- or ECL-compatible level:

- **SET TTL**
Set the input threshold to +2.5 V.
You can adjust the threshold by moving the entry focus to the value.
- **SET ECL**
Set the input threshold to -1.3 V.
You can adjust the threshold by moving the entry focus to the value.
- **VOLTAGE**
Set any threshold level in the range of -10.0 V to +10.0 V. Move the entry focus to the value to adjust it.

EXT-IN and CLK-IN Impedance Parameters

Toggle the input impedance of the external input connector or the clock input connector between 50 Ω and 10 k Ω

Trigger and Strobe Level Parameters

You can individually set the output levels of the TRIGGER OUT connector and the STROBE OUT connector.

Set the output levels (into 50 Ω) to

- **TTL**
High level: +2.50 V
Low level: 0 V
- **ECL**
High level: -0.85 V
Low level: -1.80 V

The Memory Card Screen

Use the Memory Card screen to

- store instrument settings to the memory card,
- recall instrument settings from the memory card,
- delete files from the memory card,
- format a memory card.

To access the Memory Card screen, press the MEMCARD softkey. If the MEMCARD softkey is not displayed, press MORE.

Dir Path \	 MODIFY
Filename TESTVI.TXT	*BURSTS
.....	PULSES
Perform Operation	
MODE/TRG	TRG-LEV
MEMCARD	CONFIG

Directory Path Parameter

Move the entry focus to DIR PATH to change the directory on the memory card, or to view the sub-directories of the current directory (the name of the current directory is displayed next to DIR PATH).

All sub-directories of the current directory are listed in the Modify/Enter area.

To change the directory, turn the knob to select the directory name and press the ENTER key.

Note that when you are in a sub-directory you can return to the parent-directory by selecting “..” from the directory list.

Filename Parameter

Move the entry focus to the FILENAME parameter to select a file from the current directory. Use the knob to scroll through the filenames listed in the Modify/Enter area.

Memory Card Operations

Move the entry focus to PERFORM OPERATION and use the knob to select the required operation. Press the ENTER key to perform the operation.

- READCARD
Read the DOS file system information from the memory card after inserting a new card.
- RECALL
Recall the selected file as the current instrument setting.
- STORE
Store the current instrument setting to the memory card.
Press ENTER once to start editing the filename for the setting in the Modify/Enter area. The currently selected filename is used as default.

CAUTION

If you do not modify the filename, the existing file will be overwritten when you press ENTER.

To modify the filename, move the character cursor with the cursor keys. Modify a character using the knob. When you have finished, press ENTER to store the setting.

The filename can be up to 8 characters long.

Press the cursor up or cursor down keys to cancel the store operation at any time.

Note that the DOS filename suffix “.ST0” is added automatically to the filename when you store the current settings.

- STORE ALL
Store the current instrument setting and the instrument setting memories 1 to 9 to the memory card. Each setting is stored in a separate file with the same name but different suffixes (“.ST0” for the current setting, “ST1” to “ST9” for setting memories 1 to 9).

Press ENTER once to start editing the filename for the setting in the Modify/Enter area. The currently selected filename is used as default.

CAUTION

If you do not modify the filename, the existing file will be overwritten when you press ENTER.

To modify the filename, move the character cursor with the cursor keys. Modify a character using the knob. When you have finished, press ENTER to store the setting.

The filename can be up to 8 characters long.

Press the cursor up or cursor down keys to cancel the store operation at any time.

- DELETE
Delete the selected file from the memory card.
- FORMAT
Format the memory card.

CAUTION

Formatting a memory card destroys any existing files on the card.

The Configuration Screen

Use the Configuration screen to

- set the GP-IB address of the Agilent 81101A,
- perform a selftest,
- select the frequency reference source and the frequency for the PLL.

To access the Configuration screen, press the CONFIG softkey. If the CONFIG softkey is not displayed, press MORE.

GP-IB-Address: 10	○ MODIFY		
Perform Selftest: μ P and signal			
Group Params by: TIMING/LEVELS	10		
Pulse-Period: internal PLL			
PLL-Ref: Internal			
Deskew 1: +0ps 2: +0ps			
LIMITS	TRG-LEV	MEMCARD	CONFIG

GP-IB Address

Set the GP-IB address for the instrument in the range of 0 to 30. The default address is 10.

Perform Operation Selftest

Move the entry focus to PERFORM: SELFTEST and press the ENTER key.

If the selftest fails, a flashing E is displayed. Press HELP to see the list of error messages.

PLL Reference

Set the frequency reference source for the PLL:

- **INTERNAL**
The internal 5 MHz reference.
- **CLK-IN**
An external reference signal at the CLOCK/REF INP. connector. You can set the expected frequency of the external reference to 5 MHz or 10 MHz.

Warnings and Errors

The Agilent 81101A has two levels of error reporting called “warnings” and “errors”. Checking for errors and warnings is always enabled, unless you switch it off via the GP-IB using the `:SYSTEM:CHECK` command.

- A **warning** is generated when the output signal *could* be invalid due to a combination of worst case uncertainties at the current settings of all relevant parameters.

For example, when adjusting the pulse width, all other timing parameters (leading edge, trailing edge, and pulse period) and their uncertainties have to be considered in order to check if the width setting will fit within the pulse period.

Note that the warning limits are therefore not fixed for a particular parameter, but vary with the settings of the related parameters. It is also possible that the error and warning limits are the same, that is, a warning does not occur before the error limit is reached.

If a warning occurs, the settings are still implemented in the hardware because the worst-case conditions used to evaluate the warning limits are very unlikely to occur in practice.

A blinking W indicates that one or more warnings have occurred. Press HELP to view the warning list.

- An **error** is generated when an invalid mode is chosen, or the required parameter settings cannot be implemented in the output hardware. Multiple errors can occur, but only the first error detected is displayed.

An error is indicated by a blinking error message at the bottom of the screen.

NOTE

If you are using the knob to adjust parameters it is normally not possible to generate warnings or errors. All parameters are automatically limited to settings that guarantee specified operation.

However, if you press the SHIFT key while turning the knob, you can adjust a parameter beyond its warning limits.

NOTE

You can press SHIFT + HELP (AUTOSET) to carry out an autoset. The instrument resets all parameters, based on the current period setting, to remove all warning and error conditions.

An Example of Warning and Error Reporting

- 1** Switch on the instrument and recall the standard settings by pressing SHIFT + STORE (RECALL) + 0.

The period is now set to 1 μ s.

- 2** Switch on the output by pressing SHIFT + 0 (ON/OFF).

- 3** On the Output screen, move the parameter cursor to the value of the WIDTH parameter (100NS).

- 4** Use the knob to make the pulse width as large as possible (approximately 940NS).

This limit is intended to guarantee that the actual output pulse is within specifications, for the actual period.

The limit is calculated taking into account a worst case combination of minimum period from the period setting (1 μ s) and maximum width from the width setting (940 NS) together with minimum leading and trailing edge settings (5.00 NS).

NOTE

Note that if you now try to adjust the leading edge from its current setting of 5.00 ns with the knob, it cannot be adjusted. This is because the upper and lower warning limits are currently 5.00 ns. The width is at its maximum value and width + leading edge + trailing edge \leq period.

- 5** Press SHIFT and adjust the pulse width above its warning limit. A flashing W appears to indicate that a warning condition has occurred.

NOTE

Note that as long as no errors occur, the output hardware is set up and attempts to generate the required output.

- 6** Press HELP to see the warning message:

TRAILING EDGE 1 MAY CUT NEXT PULSE

- 7** Press HELP again to return to the WIDTH parameter.

Warnings and Errors

- 8** Increase the pulse width further to approximately 980 ns and press HELP to see the current warnings:
WIDTH 1 TOO CLOSE TO PERIOD
TRAILING EDGE 1 MAY CUT NEXT PULSE
- 9** Press HELP again to return to the WIDTH parameter.
- 10** Increase the pulse width further until a flashing error message appears (approximately 1.10 μ s):
OUTPUT 1: WIDTH > PERIOD
You have reached the current upper error-limit of the WIDTH parameter.
The setting is not implemented in the output hardware.
- 11** Press SHIFT + HELP to perform an AUTOSET.

A

Installation & Maintenance

Initial Inspection

Inspect the shipping container for damage. If the container or cushioning material is damaged, keep it until the contents of the shipment have been checked for completeness and the instrument has been verified both mechanically and electrically.

WARNING

To avoid hazardous electric shock, do not perform electrical tests when there are signs of shipping damage to any part of the instrument's outer covers or panels.

If the contents are incomplete, or there is mechanical damage, or if the instrument does not work as expected within its specifications, notify the nearest Agilent office. (Please request the latest performance tests from Agilent.) Keep the shipping materials for inspection by the carrier. The Agilent office will arrange for repair or replacement without awaiting settlement.

Standard Deliverables

The Agilent 81101A shipping container contains the following standard deliverables:

1. The Agilent 81101A Pulse Generator.
2. The English Quick Start Guide and a Reference Guide.
3. A power cord.

1. Agilent 81101A Pulse Generator



2. This Quick Start Guide and the Reference Guide



3. A Power Cord



Options and Accessories:

Options

- | | |
|-----------------------|--|
| Rear Panel Connectors | Option UN2
All inputs and outputs are at the rear panel |
| 1 MB SRAM Memory Card | Option UFJ
(Agilent part number 0950-3380) |

The following figure shows the instruments rear panel with Option UN2 installed.

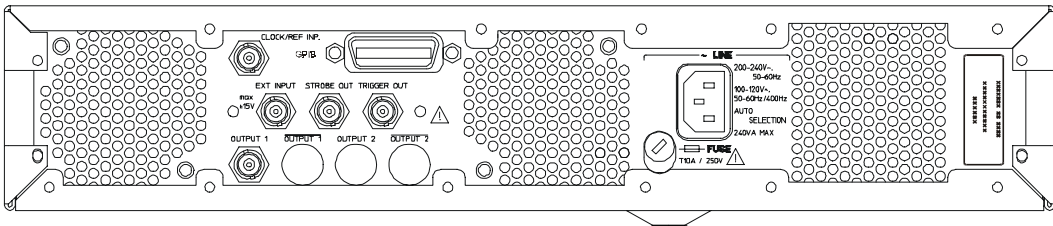

Handle Accessory

- | | |
|------------------|-------------------------------|
| Front Handle Kit | Agilent part number 5063-9226 |
|------------------|-------------------------------|

Rack Mounting Accessories

- | | |
|---------------------------------|-------------------------------|
| Rack Mount Kit | Agilent part number 5063-9212 |
| Rack Mount and Front Handle Kit | Agilent part number 5063-9219 |
| Rack Slide Kit | Agilent part number 1494-0059 |

Quick Start Guide Language Options

French Guide	Option ABF (Agilent part number 81101-91220)
Japanese Guide	Option ABJ (Agilent part number 81101-91520)
Taiwan Chinese Guide	Option AB0 (Agilent part number 81101-91620)
Korean Guide	Option AB1 (Agilent part number 81101-91720)
Chinese Guide	Option AB2 (Agilent part number 81101-91820)

Additional Documentation Options

Service Manual	Option 0BW (Agilent part number 81101-91021)
----------------	---

Power Requirements

CAUTION

Before applying AC line power to the instrument, ensure that the correct line fuse is installed in the fuse holder and the correct power cable is fitted.

NOTE

When the front panel switch is off, the instrument is in “standby” mode. The instrument is disconnected from the AC line power *only* by disconnecting the power cord. Please make sure that the power cord is easily identifiable and can quickly be reached by the operator.

The following symbol is close to the ‘Standby’ switch on the front panel of the instrument.



The instrument can operate from any single-phase AC power source supplying 100–240 V in the frequency range from 50 to 60 Hz, or 100–120 V at 400 Hz. The maximum power consumption is 300 VA with all options installed. When the instrument is switched on the power supply adapts automatically to the applied AC power (Auto Selection) and monitors the AC power range during operation.

Replacing the Fuse



- 1 Remove the power cord.
- 2 Unscrew the fuse cap at the rear of the instrument beside the power-inlet socket.

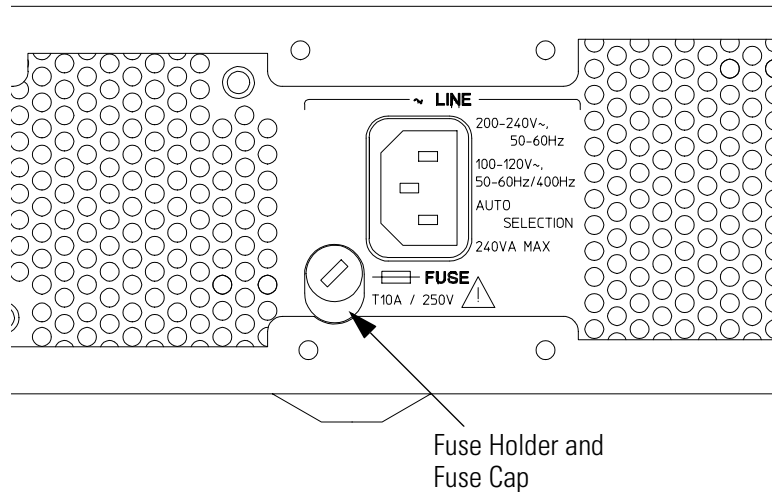

- 3 Replace the fuse with the equivalent part:

Line Voltage	Fuse Type	Agilent Part Number
100–240 V~	T 10A, 250 V	2110-0720

- 4 Refit the fuse cap.

Power Cable

In accordance with international safety standards, this instrument is equipped with a three-wire power cable. The figure below shows the part numbers of the power cables available. When connected to an appropriate AC power receptacle, this cable grounds the instrument cabinet.

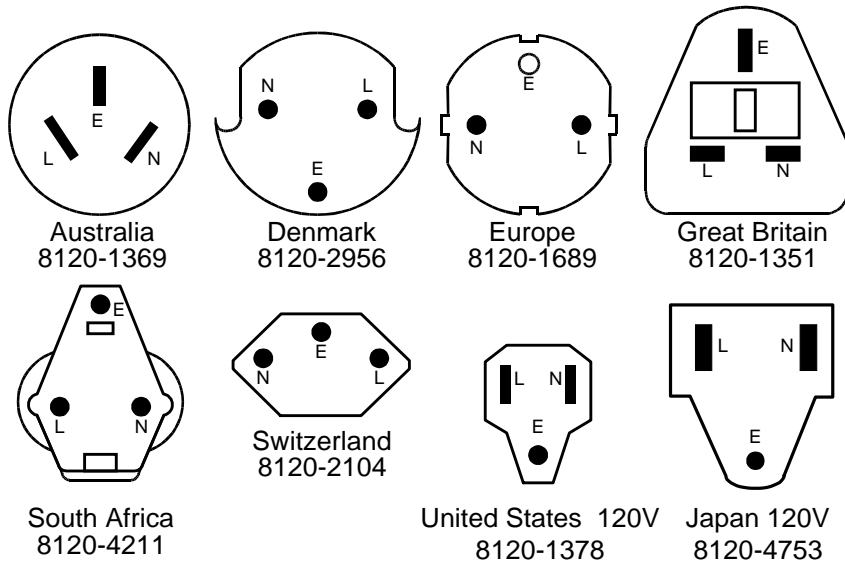

Ventilation Requirements

The instrument is fitted with three cooling fans. Make sure that there is adequate clearance of 80 mm at the rear and 25 mm at the top and bottom to ensure adequate air flow. If the air flow is restricted, the internal operating temperature will be higher, reducing the instrument's reliability or causing the instrument's thermal-protection circuits to automatically switch off the instrument.

NOTE

Do not cover the ventilation holes.

Thermal Protection

Overheating Detection

The instrument monitors its internal temperature. If the temperature exceeds approximately 80°C, the power supply is switched off. The instrument will switch on again if the temperature falls below approximately 77°C.

Fan Failure

If a fan is broken or prevented from operating by a blockage, the temperature will increase. When the temperature exceeds approximately 80°C the overheating detection switches off the instrument for safety reasons. For reliability it is recommended to send instruments with broken or defective fans immediately to Agilent Service for repair.

Battery



This instrument contains a lithium battery. Typical life time of the battery is about 5 years.

NOTE

Recycle or dispose used batteries according to local regulations. Or contact your Agilent representative for information on battery recycling.

The battery is replaceable. Replacement should only be carried out by *qualified service personnel*.

NOTE

There is a danger of explosion if the battery is incorrectly replaced.

The battery must be replaced with the same or equivalent battery type:

A **Lithium CR2477-N** type battery.

The Agilent replacement part number is: **1420-0557**.

The battery is protected against charging.

CAUTION

Do *not* crush, puncture, or incinerate the battery. Do *not* short the battery's external contacts.



Battery Replacement

NOTE

Disconnect the power cord from AC line voltage to avoid electrical shock.

- 1 Remove the bumper which is fitted to the front panel.**
- 2** Remove the strips on the left and right side of the front panel.
- 3** Remove the front panel which is secured with two screws at each side.
- 4** Disconnect the flat cable which connects the front panel to the chassis.
- 5** On the right side of the chassis there is a cover secured with one screw. Remove this cover.
- 6** Now the battery can be removed from the battery holder. It is recommended to push the battery on the top, and to pull the battery on the bottom with one finger for easier removal.
- 7** Fit the new battery in the holder, take care to not short current the battery on the chassis.
- 8** Fit the cover again and secure it with the screw to the chassis.
- 9** Re-connect the flat cable of the front panel again to the chassis connector. Make sure that the pin one (red wire) is pointing to the mid of the chassis.
- 10** Re-assemble the front cover.
- 11** Fit the strips to the sides of the front panel, again.
- 12** Fit the bumper to the front panel.

Operating Environment

Storage Temperature	-40 °C to +70 °C
Operating Temperature	0 °C to 55 °C
Humidity	95% R.H. (at 40 °C)
Altitude	Up to 2000m
Installation	Category II
Pollution	Degree 2

WARNING

The instrument is not designed for outdoor use. Do not expose the instrument to rain or other excessive moisture. Protect the instrument from humidity and temperature changes which could cause condensation within the instrument.

Do not operate the instrument in the presence of flammable gases, fumes or powders. Operation of any electrical instrument in such an environment constitutes a definite safety hazard.

Cleaning Recommendation

WARNING

To prevent electrical shock, disconnect the instrument from mains before cleaning. Use a dry cloth or one slightly dampened with water to clean external case parts. Do not attempt to clean internally.

Acoustic Noise Emission

Acoustic Noise Emission

For ambient temperatures up to 30°C, under normal operation and at the typical operator position:

LpA = 52 dBA

Measured in accordance with ISO 7779 / EN 27779.

Geräuschemissionswerte

Bei einer Umgebungstemperatur bis 30°C

LpA = 52 dBA

am Arbeitsplatz, normaler Betrieb.

Angabe ist das Ergebnis einer Typprüfung nach ISO 7779 / EN 27779.

Index

A

- Accessories 78
- Acoustic Noise Emission 88
- Additional Documentation 79
- Amplitude Parameter 62
- Automated Testing 17
- Autoset 26, 73

B

- Battery 84
 - disposal 84
 - for memory back-up 84
 - replacement 85
 - type 84
- Benefits 16
- Burst Mode
 - continuous 47
 - gated 54
 - triggered 50
- Burst Signal
 - command list 42
 - example 39

C

- Cable 82
- Capabilities
 - signal generation 16
- Certification
 - met specifications 5
- Cleaning Recommendation 87
- Clock Signal
 - command list 34
 - example 30
- CLOCK/REF INP. connector 28
- Command Language 17
- Command List
 - burst signal 42
 - clock signal 34
 - pulse signal 38
- Conditions, environmental 86
- Configuration Screen 70
- Connectors
 - front panel 18
 - rear panel 28
- Continuous Mode
 - burst 47
 - pulses 46
- Current limits 64

D

- Digits 25
- Directory 67
- Documentation, additional 79

E

- Emission
 - acoustic noise 88
- Environmental Conditions 86
- Error checking 72
- Errors 26, 72
- Examples
 - burst signal 39
 - clock signal 30
 - pulse signal 35
- Exceed
 - Specified Values 25
- EXT INPUT
 - front panel 19
 - Impedance 66
 - rear panel 28
- EXT INPUT Threshold 65
- External PLL Reference 70
- External Width Mode 55

F

- Features 16
- Front Panel 18

G

- Gating
 - gated burst mode 54
 - gated pulses mode 52
 - manual 26
 - sources 45
- GP-IB
 - Address 70
 - automated testing 17
 - connector 28
- Graphical Display 22

H

- Handle Accessory 78
- Help Information 26
- High Accurate Frequency 45
- High Level Parameter 62

I

- IC Technologies 16
- Input Impedance 66

Index

Inspection 76
Installation 76

K

Knob 18

L

Language Options 79
Leading Edge Parameter 59
Level Parameters 61
Limits
 overprogramming 25
 screen 64
Line Fuse 80
Load Impedance Parameter 63
LOCAL key 26
Logic Technologies 16
Low Level Parameter 62

M

MAN Key 26, 48, 50, 52, 54
Memory Card Screen 67
Modify
 resolution 25
Modify Knob 18
MORE key 18

N

Normal/Complement Parameter 62

O

Offset Parameter 62
On-line Help 26
Operating Environment 84, 86
Options 78
OUTPUT connector 19
Output Screen 56
Output Source Impedance Parameter 63
Overprogramming 25

P

Parameter
 step size 25
Parameters
 levels 61
 timing 56
Path 67
PLL 45
 reference source 71
PLL Reference 70

Power Cable 82
Power Consumption 80
Power Cord 77, 82
Power Requirements 80
Power Source 80
Product Features 16
Pulse Capabilities 16
Pulse Delay Parameter 58
Pulse Period
 parameter 57
 source 45
Pulse Signal
 command list 38
 example 35
Pulse Trailing Edge Parameter 60
Pulse Width Parameter 59
Pulses Mode
 continuous 46
 gated 52
 triggered 48

R

Rack Mounting 78
Rear Panel 28
Recalling Settings
 internal memory 26
 memory card 67
Remote
 control 17
 programming 17
 unlock 26
Resolution 25
Rotary Knob 18

S

Safety
 symbols 8
SCPI 17
Selftest 70
Service Documentation 79
Shift Key 25, 26
Signal Generation Capabilities 16
Standard Deliverables 77
Standby Switch 80
Startable Oscillator 45
Storing Settings
 internal memory 26
 memory card 67
STROBE OUT connector 19

Index

Switch, standby 80

T

Threshold 65

Timing Parameters 56

Timing Variations

 dropout free 16, 56

 glitch free 16, 56

TRIGGER OUT connector 19

TRIGGER OUT levels 66

Triggering

 manual 26

 sources 45

 triggered burst mode 50

 triggered pulses mode 48

Trigger-Level Screen 65

U

Unlock Front Panel 26

Use Models 16

V

Ventilation Requirements 83

VFO 45

Voltage limits 64

Voltage/Current Mode Parameter 63

W

Warnings 26, 72

Index

Front Panel Controls

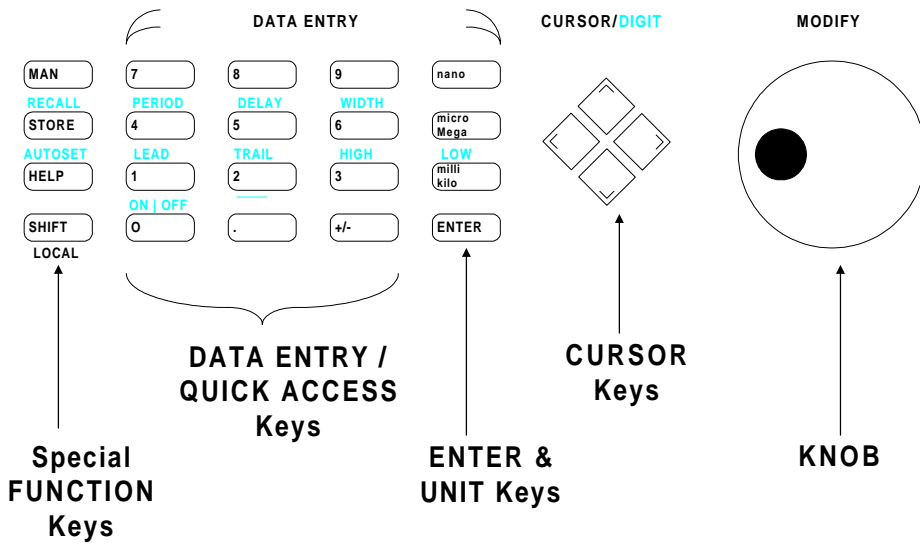

Copyright Agilent Technologies 1998, 2000
Edition E0300
Printed in Germany

81101-91020